

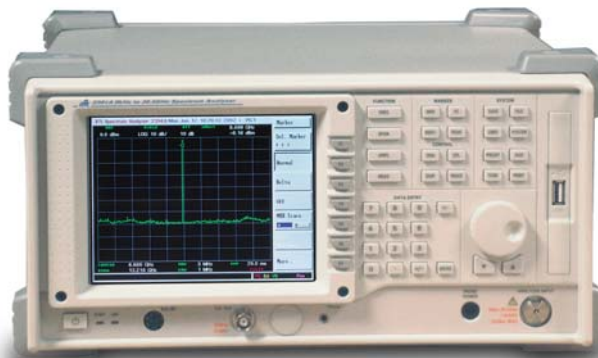

SPECTRUM ANALYZERS

2394A/2395A



Operating Manual

Document part no. 46892/591

Issue 3

13 June 2007



SPECTRUM ANALYZERS

2394A/2395A

Operating Manual

© Aeroflex International Ltd. 2007

*No part of this document may be reproduced or transmitted in any form
or by any means, electronic or mechanical, including photocopying,
or recorded by any information storage or retrieval system,
without permission in writing by Aeroflex International Ltd.
(hereafter referred to throughout the document as 'Aeroflex').*

Manual part no. 46892/591 (PDF version)

Based on Issue 3 of the printed manual

13 June 2007

Read this manual before using the equipment.

Keep this manual with the equipment

Safety Symbols

Where these symbols or indications appear on the equipment or in this manual, they have the following meanings.



WARNING *Risk of hazard which cause injury to human body or danger to life, If a WARNING appears on the equipment, and in this manual, do not proceed until its suitable conditions are understood and met*



CAUTION. *Risk of hazard that caused fire or serious damage to the equipment or other equipment. Do not proceed until its suitable conditions are met.*



GROUND. *Ground terminal to chassis (earth).*

For Symbols

WARNING



1. ALWAYS refer to the operation manual when working near locations at which the alert mark shown on the left is attached. If the operation, etc., is performed without heeding the advice in the operation manual, there is a risk of personal injury. In addition, the equipment performance may be reduced.

Moreover, this alert mark is sometimes used with other marks and descriptions indicating other dangers.



2. When supplying power to this equipment, connect the accessory 3-pin power cord to a 3-pin grounded power outlet. If a grounded 3-pin outlet is not available, use a conversion adapter and ground the green wire, or connect the frame ground on the rear panel of the equipment to ground. If power is supplied without grounding the equipment, there is a risk of receiving a severe or fatal electric shock and equipment damage.

Repair

WARNING



3. The user cannot repair this equipment. DO NOT attempt to open the cabinet or to disassemble internal parts. Only trained service personnel or staff from your sales representative with knowledge of electrical fire and shock hazards should service this equipment. There are high-voltage parts in this equipment presenting a risk of severe injury or fatal electric shock to untrained personnel. In addition, there is a risk of damage to internal parts.

Falling Over

4. This equipment should be used in the correct position, If the cabinet is turned on its side, etc., it will be unstable and may be damaged if it falls over as a result of receiving a slight mechanical shock.
-

For Symbols

CAUTION

Changing Fuse

CAUTION

1. Before changing the fuses, ALWAYS remove the power cord from the power-outlet and replace the blown fuses. ALWAYS use new fuses of the type and rating specified on the fuse marking on the rear panel cabinet.

T3.15A indicates a time-lag fuse.

There is risk of receiving a fatal electric shock if the fuses are replaced with the power cord connected.

Cleaning

2. Keep the power supply and cooling fan free of dust.
 - Clean the power inlet regularly. If dust accumulates around the power pins, there is a risk of fire.
 - Keep the cooling fan clean so that the ventilation holes are not obstructed. If the ventilation is obstructed, the cabinet may overheat and catch fire.

Check Terminal



3.
 - Maximum DC voltage ratings :
RF Input connector : ± 50 VDC
 - Maximum RF power ratings :
RF Input power : +30 dBm
 - NEVER input $> +30$ dBm and > 50 VDC power to RF Input.
 - Excessive power may damage the internal circuits.

For Symbols

CAUTION



Replacing Memory

Backup Battery



4. A Primary Lithium Battery supplies the power for CMOS backup. This battery should only be replaced by a battery of the same type ; since Aeroflex can only make replacement, contact the nearest Aeroflex representative when replacement is required.

CAUTION



Note : The battery life is about 7 years. Early battery replacement is recommended

Storage

Medium

Do not throw the battery away but dispose of it according to your country's requirement.

5. This equipment stores data and programs using USB Port in the USB Storage or USB Floppy.
Data and programs may be lost due to improper use or failure. Aeroflex therefore recommends that you back-up the memory. (USB Port can not support an USB Keyboard & Mouse.)

Aeroflex CANNOT COMPENSATE FOR ANY MEMORY LOSS.

CAUTION



6. **Use Proper Power Source** : Do not operate this product from a power source that applies more than the voltage specified.

Provide Proper Ventilation : To prevent product overheating, provide proper ventilation.

For Symbols



Product Damage
Precaution

Do Not Operate With Suspected Failures : If you suspect there is damage to this product, have it inspected by qualified service personnel.

Do Not Attempt To Operate If Protection May Be Impaired : If the equipment appears damaged or operated abnormally, protection may be impaired. Do not attempt to operate the equipment under these conditions. Refer all questions of proper equipment operation to qualified service personnel.

7. **Object and Liquid Entry** : Never push objects of any kind into equipment through openings as they may touch dangerous voltage points or short out parts that could result in a fire or electric shock. Never spill liquid of any kind on the equipment.

Place-related
Warning

Do not use this equipment near water– for example, near a bathtub, wash bowl, kitchen sink, or laundry tub, in a wet basement, or near a swimming pool, and the like. Keep the equipment away from damp air, water and dust. Unexpected trouble may be caused when the equipment is placed in a damp or dusty place.



Flammable and Explosive Substance : Avoid using this equipment where there are gases, and where there are flammable and explosive substances in the immediate vicinity.

Unstable Location : Do not place this equipment on an unstable cart, stand, tripod, bracket, or table. This equipment may fall, causing serious injury to a person, and serious damage to the equipment. Do not place or use the equipment in a place subject to vibration.

Precautions

WARNING

CAUTION

Note

These terms have specific meanings in this manual:

WARNING

information to prevent personal injury.

CAUTION





information to prevent damage to the equipment.

Note

important general information.

Symbols

The meaning of hazard symbols appearing on the equipment and in the documentation is as follows:

Symbol	Description
	Refer to the operating manual when this symbol is marked on the instrument. Familiarize yourself with the nature of the hazard and the actions that may have to be taken.
	Dangerous voltage
	Toxic hazard
	Static sensitive components

General conditions of use

This product is designed and tested to comply with the requirements of IEC/EN61010-1 'Safety requirements for electrical equipment for measurement, control and laboratory use', for Class I portable equipment and is for use in a pollution degree 2 environment. The equipment is designed to operate from an installation category II supply.

Equipment should be protected from the ingress of liquids and precipitation such as rain, snow, etc. When moving the equipment from a cold to a hot environment, it is important to allow the temperature of the equipment to stabilize before it is connected to the supply to avoid condensation forming. The equipment must only be operated within the environmental conditions specified in Chapter 1 in the Operating Manual, otherwise the protection provided by the equipment may be impaired.

This product is not approved for use in hazardous atmospheres or medical applications. If the equipment is to be used in a safety-related application, e.g. avionics or military applications, the suitability of the product must be assessed and approved for use by a competent person.

WARNING



Electrical hazards (AC supply voltage)

This equipment conforms with IEC Safety Class I, meaning that it is provided with a protective grounding lead. To maintain this protection the supply lead must always be connected to the source of supply via a socket with a grounded contact.

Be aware that the supply filter contains capacitors that may remain charged after the equipment is disconnected from the supply. Although the stored energy is within the approved safety requirements, a slight shock may be felt if the plug pins are touched immediately after removal.

Do not remove instrument covers as this may result in personal injury. There are no user-serviceable parts inside.

Refer all servicing to qualified personnel. See list of Service Centers at rear of manual.

WARNING



Fire hazard

Make sure that only fuses of the correct rating and type are used for replacement.

If an integrally fused plug is used on the supply lead, ensure that the fuse rating is commensurate with the current requirements of this equipment.

WARNING



Toxic hazards

Some of the components used in this equipment may include resins and other materials which give off toxic fumes if incinerated. Take appropriate precautions, therefore, in the disposal of these items.

WARNING



Beryllium copper

Some mechanical components within this instrument are manufactured from beryllium copper. This is an alloy with a beryllium content of approximately 5%. It represents no risk in normal use.

The material should not be machined, welded or subjected to any process where heat is involved.

It must be disposed of as “special waste”.

It must NOT be disposed of by incineration.

WARNING



Lithium

A Lithium battery (or a Lithium battery contained within an IC) is used in this equipment.

As Lithium is a toxic substance, the battery should in no circumstances be crushed, incinerated or disposed of in normal waste.

Do not attempt to recharge this type of battery. Do not short circuit or force discharge since this might cause the battery to vent, overheat or explode.

WARNING**Tilt facility**

When the equipment is in the tilt position, it is advisable, for stability reasons, not to stack other equipment on top of it.

CAUTION**Static sensitive components**

This equipment contains static sensitive components which may be damaged by handling — refer to the Maintenance part of the Service Manual for handling precautions.

CAUTION**Precision connector**

The precision microwave connectors fitted to this equipment may be damaged by mating with a non-precision type. Damage to the connector may also occur if the connector interface parameters are not within specification. The connector should be checked with the appropriate gauging tool.

CAUTION**Suitability for use**

This equipment has been designed and manufactured by Aeroflex to perform measurements on RF and microwave components and systems.

If the equipment is not used in a manner specified by Aeroflex, the protection provided by the equipment may be impaired.

Aeroflex has no control over the use of this equipment and cannot be held responsible for events arising from its use other than for its intended purpose.

Précautions

WARNING

CAUTION

Note

Les termes suivants ont, dans ce manuel, des significations particulières:

WARNING

contient des informations pour éviter toute blessure au personnel.

CAUTION

contient des informations pour éviter les dommages aux équipements.

Note

contient d'importantes informations d'ordre général.

Symboles signalant un risque

La signification des symboles de danger apparaissant sur l'équipement et dans la documentation est la suivante:

Symbole

Nature du risque



Reportez-vous au manuel d'utilisation quand ce symbole apparaît sur l'instrument. Familiarisez-vous avec la nature du danger et la conduite à tenir.



Tension dangereuse



Danger produits toxiques

Conditions générales d'utilisation

Ce produit a été conçu et testé pour être conforme aux exigences des normes CEI/EN61010-1 "Règles de sécurité pour appareils électriques de mesurage, de régulation et de laboratoire", pour des équipements Classe I portables et pour une utilisation dans un environnement de pollution de niveau 2. Cet équipement est conçu pour fonctionner à partir d'une alimentation de catégorie II.

Cet équipement doit être protégé de l'introduction de liquides ainsi que des précipitations d'eau, de neige, etc... Lorsqu'on transporte cet équipement d'un environnement chaud vers un environnement froid, il est important de laisser l'équipement se stabiliser en température avant de le connecter à une alimentation afin d'éviter toute formation de condensation.

L'appareil doit être utilisé uniquement dans le cadre des conditions d'environnement spécifiées au chapitre 1 'Performance data' du manuel d'utilisation, toute autre utilisation peut endommager les systèmes de protection.

Ce produit n'est pas garanti pour fonctionner dans des atmosphères dangereuses ou pour un usage médical. Si l'équipement doit être utilisé pour des applications en relation avec la sécurité, par exemple des applications militaires ou aéronautiques, la compatibilité du produit doit être établie et approuvée par une personne compétente.

WARNING



Sécurité électrique (tension d'alimentation alternative)

Cet appareil est protégé conformément à la norme CEI de sécurité Classe 1, c'est-à-dire que sa prise secteur comporte un fil de protection à la terre. Pour maintenir cette protection, le câble d'alimentation doit toujours être branché à la source d'alimentation par l'intermédiaire d'une prise comportant une borne de terre.

Notez que les filtres d'alimentation contiennent des condensateurs qui peuvent encore être chargés lorsque l'appareil est débranché. Bien que l'énergie contenue soit conforme aux exigences de sécurité, il est possible de ressentir un léger choc si l'on touche les bornes sitôt après débranchement.

Ne démontez pas le capot de l'instrument, car ceci peut provoquer des blessures. Il n'y a pas de pièces remplaçables par l'utilisateur à l'intérieur.

Faites effectuer toute réparation par du personnel qualifié. Contacter un des Centres de Maintenance Internationaux dans la liste jointe à la fin du manuel.

WARNING



Risque lié au feu

Lors du remplacement des fusibles vérifiez l'exactitude de leur type et de leur valeur. Si le câble d'alimentation comporte une prise avec fusible intégré, assurez vous que sa valeur est compatible avec les besoins en courant de l'appareil.

WARNING



Danger produits toxiques

Certains composants utilisés dans cet appareil peuvent contenir des résines et d'autres matières qui dégagent des fumées toxiques lors de leur incinération. Les précautions d'usages doivent donc être prises lorsqu'on se débarrasse de ce type de composant.

WARNING**Bronze au béryllium**

Dans cet équipement, certaines pièces mécaniques sont à base de bronze au béryllium. Il s'agit d'un alliage dans lequel le pourcentage de béryllium ne dépasse pas 5%. Il ne présente aucun danger en utilisation normale.

Toutefois, cet alliage ne doit pas être travaillé, soudé ou soumis à un processus qui implique l'utilisation d'une source de chaleur.

En cas de destruction, il sera entreposé dans un container spécial. IL ne devra pas être détruit par incinération

WARNING**Lithium**

Une pile au Lithium ou un CI contenant une pile au Lithium est utilisé dans cet équipement. Le Lithium étant une substance toxique, il ne faut en aucun cas l'écraser, l'incinérer ou le jeter avec des déchets normaux.

N'essayez pas de recharger ce type de pile. Ne court-circuitez pas ou ne forcez pas la décharge de la pile car cela pourrait causer une fuite, une surchauffe ou une explosion.

WARNING**Position inclinée**

Lorsque l'appareil est dans une position inclinée, il est recommandé, pour des raisons de stabilité, de ne pas y empiler d'autres appareils.

CAUTION**Utilisation**

Cet équipement a été conçu et fabriqué par Aeroflex pour effectuer des mesures sur des composants et des systèmes RF et hyperfréquences

La protection de l'équipement peut être altérée s'il n'est pas utilisé dans les conditions spécifiées par Aeroflex.

Aeroflex n'a aucun contrôle sur l'usage de l'instrument, et ne pourra être tenu pour responsable en cas d'événement survenant suite à une utilisation différente de celle prévue.

Vorsichtsmaßnahmen

WARNING

CAUTION

Note

Diese Hinweise haben eine bestimmte Bedeutung in diesem Handbuch:

WARNING

dienen zur Vermeidung von Verletzungsrisiken.

CAUTION

dienen dem Schutz der Geräte.

Note

enthalten wichtige Informationen.

Gefahrensymbole

Die Bedeutung der Gefahrensymbole auf den Geräten und in der Dokumentation ist wie folgt:

Symbol

Gefahrenart



Beziehen Sie sich auf die Bedienungsanleitung wenn das Messgerät mit diesem Symbol markiert ist. Machen Sie sich mit der Art der Gefahr und den Aktionen die getroffen werden müssen bekannt.



Gefährliche Spannung



Warnung vor giftigen Substanzen

Allgemeine Hinweise zur Verwendung

Dieses Produkt wurde entsprechend den Anforderungen von IEC/EN61010-1

“Sicherheitsanforderungen für elektrische Ausrüstung für Meßaufgaben, Steuerung und Laborbedarf”, Klasse I transportabel zur Verwendung in einer Grad 2 verunreinigten Umgebung, entwickelt und getestet. Dieses Gerät ist für Netzversorgung Klasse II zugelassen.

Das Gerät sollte vor dem Eindringen von Flüssigkeiten sowie vor Regen, Schnee etc. geschützt werden. Bei Standortänderung von kalter in wärmere Umgebung sollte das Gerät wegen der Kondensation erst nach Anpassung an die wärmere Umgebung mit dem Netz verbunden werden. Das Gerät darf nur in Umgebungsbedingungen wie im Kapitel 1 ‘Lesungsdaten (Performance data)’ der Bedienungsanleitung beschrieben, betrieben werden; ansonsten wird der vom Gerät vorgesehene Schutz des Anwenders beeinträchtigt.

Dieses Produkt ist nicht für den Einsatz in gefährlicher Umgebung (z.B. Ex-Bereich) und für medizinische Anwendungen geprüft. Sollte das Gerät für den Einsatz in sicherheitsrelevanten Anwendungen wie z.B. im Flugverkehr oder bei militärischen Anwendungen vorgesehen sein, so ist dieser von einer für diesen Bereich zuständigen Person zu beurteilen und genehmigen.

WARNING



Elektrische Schläge (Wechselspannungsversorgung)

Das Gerät entspricht IEC Sicherheitsklasse 1 mit einem Schutzleiter nach Erde. Das Netzkabel muß stets an eine Steckdose mit Erdkontakt angeschlossen werden.

Filterkondensatoren in der internen Spannungsversorgung können auch nach Unterbrechung der Spannungszuführung noch geladen sein. Obwohl die darin gespeicherte Energie innerhalb der Sicherheitsmargen liegt, kann ein leichter Spannungsschlag bei Berührung kurz nach der Unterbrechung erfolgen.

Öffnen Sie niemals das Gehäuse der Geräte das dies zu ernsthaften Verletzungen führen kann. Es gibt keine vom Anwender austauschbare Teile in diesem Gerät.

Lassen Sie alle Reparaturen durch qualifiziertes Personal durchführen. Eine Liste der Servicestellen finden Sie auf der Rückseite des Handbuchs.

WARNING



Feuergefahr

Es dürfen nur Ersatzsicherungen vom gleichen Typ mit den korrekten Spezifikationen entsprechend der Stromaufnahme des Gerätes verwendet werden.

WARNING**Warnung vor giftigen Substanzen**

In einigen Bauelementen dieses Geräts können Epoxyharze oder andere Materialien enthalten sein, die im Brandfall giftige Gase erzeugen. Bei der Entsorgung müssen deshalb entsprechende Vorsichtsmaßnahmen getroffen werden.

WARNING**Beryllium Kupfer**

In diesem Gerät sind einige mechanische Komponenten aus Beryllium Kupfer gefertigt. Dies ist eine Verbindung welche aus einem Berylliumanteil von ca. 5 % besteht. Bei normaler Verwendung besteht kein Gesundheitsrisiko.

Das Metall darf nicht bearbeitet, geschweißt oder sonstiger Wärmebehandlung ausgesetzt werden.

Es muß als Sondermüll entsorgt werden.

Es darf nicht durch Verbrennung entsorgt werden.

WARNING**Lithium**

Eine Lithium Batterie oder eine Lithium Batterie innerhalb eines IC ist in diesem Gerät eingebaut.

Da Lithium ein giftiges Material ist, sollte es als Sondermüll entsorgt werden.

Diese Batterie darf auf keinen Fall geladen werden. Nicht kurzschließen, da sie dabei überhitzt werden und explodieren kann.

WARNING**Schrägstellung**

Bei Schrägstellung des Geräts sollten aus Stabilitätsgründen keine anderen Geräte darauf gestellt werden.

CAUTION

Eignung für Gebrauch

Dieses Gerät wurde von Aeroflex entwickelt und hergestellt um Messungen an HF- und Mikrowellenkomponenten und -Systemen durchzuführen

Sollte das Gerät nicht auf die von Aeroflex vorgesehene Art und Weise verwendet werden, kann die Schutzfunktion des Gerätes beeinträchtigt werden.

Aeroflex hat keinen Einfluß auf die Art der Verwendung und übernimmt keinerlei Verantwortung bei unsachgemässer Handhabung.

Precauzioni

WARNING

CAUTION

Note

Questi termini vengono utilizzati in questo manuale con significati specifici:

WARNING

riportano informazioni atte ad evitare possibili pericoli alla persona.

CAUTION

riportano informazioni per evitare possibili pericoli all'apparecchiatura.

Note

riportano importanti informazioni di carattere generale.

Simboli di pericolo

Il significato del simbolo di pericolo riportato sugli strumenti e nella documentazione è il seguente:

Simbolo

Tipo di pericolo



Fare riferimento al manuale operativo quando questo simbolo è riportato sullo strumento. Rendervi conto della natura del pericolo e delle precauzioni che dovrete prendere.



Tensione pericolosa



Pericolo sostanze tossiche

Condizioni generali d'uso

Questo prodotto è stato progettato e collaudato per rispondere ai requisiti della direttiva IEC/EN61010-1 'Safety requirements for electrical equipment for measurement, control and laboratory use' per apparati di classe I portatili e per l'uso in un ambiente inquinato di grado 2. L'apparato è stato progettato per essere alimentato da un alimentatore di categoria II.

Lo strumento deve essere protetto dal possibile ingresso di liquidi quali, ad es., acqua, pioggia, neve, ecc. Qualora lo strumento venga portato da un ambiente freddo ad uno caldo, è importante lasciare che la temperatura all'interno dello strumento si stabilizzi prima di alimentarlo per evitare formazione di condense. Lo strumento deve essere utilizzato esclusivamente nelle condizioni ambientali descritte nel capitolo 1 'Performance data' del manuale operativo, in caso contrario le protezioni previste nello strumento potrebbero risultare non sufficienti.

Questo prodotto non è stato approvato per essere usato in ambienti pericolosi o applicazioni medicali. Se lo strumento deve essere usato per applicazioni particolari collegate alla sicurezza (per esempio applicazioni militari o avioniche), occorre che una persona o un istituto competente ne certifichi l'uso.

WARNING



Pericoli da elettricità (alimentazione c.a.)

Quest 'apparato è provvisto del collegamento di protezione di terra e rispetta le norme di sicurezza IEC, classe 1. Per mantenere questa protezione è necessario che il cavo, la spina e la presa d'alimentazione siano tutti provvisti di terra.

Il circuito d'alimentazione contiene dei filtri i cui condensatori possono restare carichi anche dopo aver rimosso l'alimentazione. Sebbene l'energia immagazzinata è entro i limiti di sicurezza, purtuttavia una leggera scossa può essere avvertita toccando i capi della spina subito dopo averla rimossa.

Non rimuovete mai le coperture perché così potreste provocare danni a voi stessi. Non vi sono all'interno parti di interesse all'utilizzatore.

Tutte gli interventi sono di competenza del personale qualificato. Vedi elenco internazionale dei Centri di Assistenza in fondo al manuale.

WARNING



Pericolo d'incendio

Assicurarsi che, in caso di sostituzione, vengano utilizzati solo fusibili della portata e del tipo prescritti.

Se viene usata una spina con fusibili, assicurarsi che questi siano di portata adeguata ai requisiti di alimentazione richiesti dallo strumento.

WARNING**Pericolo sostanze tossiche**

Alcuni dei componenti usati in questo strumento possono contenere resine o altri materiali che, se bruciati, possono emettere fumi tossici. Prendere quindi le opportune precauzioni nell'uso di tali parti.

WARNING**Rame berillio**

Alcuni componenti meccanici in questo strumento sono realizzati in rame berillio. Si tratta di una lega con contenuto di berillio di circa il 5%, che non presenta alcun rischio in usi normali.

Questo materiale non deve essere lavorato, saldato o subire qualsiasi processo che coinvolge alte temperature.

Deve essere eliminato come "rifiuto speciale". Non deve essere eliminato tramite "inceneritore".

WARNING**Litio**

Quest 'apparato incorpora una batteria al litio o un circuito integrato contenente una batteria al litio.

Poiché il litio è una sostanza tossica, la batteria non deve essere mai né rotta, né incenerita, né gettata tra i normali rifiuti.

Questo tipo di batteria non può essere sottoposto né a ricarica né a corto-circuito o scarica forzata. Queste azioni possono provocare surriscaldamento, fuoriuscita di gas o esplosione della batteria.

WARNING**Posizionamento inclinato**

Quando lo strumento è in posizione inclinata è raccomandato, per motivi di stabilità, non sovrapporre altri strumenti.

CAUTION**Caratteristiche d'uso**

Questo strumento è stato progettato e prodotto da Aeroflex eseguire misure su componenti o sistemi RF e microonde

Se lo strumento non è utilizzato nel modo specificato da Aeroflex, le protezioni previste sullo strumento potrebbero risultare inefficaci.

Aeroflex non può avere il controllo sull'uso di questo strumento e non può essere ritenuta responsabile per eventi risultanti da un uso diverso dallo scopo prefisso.

Precauciones

WARNING

CAUTION

Note

Estos términos tienen significados específicos en este manual:

WARNING

contienen información referente a prevención de daños personales.

CAUTION



contienen información referente a prevención de daños en equipos.

Note

contienen información general importante.

Símbolos de peligro

El significado de los símbolos de peligro en el equipo y en la documentación es el siguiente:

Símbolo	Naturaleza del peligro
	Vea el manual de funcionamiento cuando este símbolo aparezca en el instrumento. Familiarícese con la naturaleza del riesgo y con las acciones que deban de tomarse.
	Voltaje peligroso
	Aviso de toxicidad

Condiciones generales de uso

Este producto ha sido diseñado y probado para cumplir los requerimientos de la normativa IEC/EN61010-1 “Requerimientos de la normativa para equipos eléctricos de medida, control y uso en laboratorio”, para equipos clase I portátiles y para uso en un ambiente con un grado de contaminación 2. El equipo ha sido diseñado para funcionar sobre una instalación de alimentación de categorías II.

Debe protegerse el equipo de la entrada de líquidos y precipitaciones como nieve, lluvia, etc. Cuando se traslada el equipo de entorno frío a un entorno caliente, es importante aguardar la estabilización del equipo para evitar la condensación. Solamente debe utilizarse el equipo bajo las condiciones ambientales especificadas en el capítulo 1 “Especificaciones” o “Performance data” del Manual de Instrucciones, en caso contrario la propia protección del equipo puede resultar dañada.

Este producto no ha sido aprobado para su utilización en entornos peligrosos o en aplicaciones médicas. Si se va a utilizar el equipo en una aplicación con implicaciones en cuanto a seguridad, como por ejemplo aplicaciones de aviónica o militares, es preciso que un experto competente en materia de seguridad apruebe su uso.

WARNING



Nivel peligroso de electricidad (tensión de red)

Este equipo cumple las normas IEC Seguridad Clase 1, lo que significa que va provisto de un cable de protección de masa. Para mantener esta protección, el cable de alimentación de red debe de conectarse siempre a una clavija con terminal de masa.

Tenga en cuenta que el filtro de red contiene condensadores que pueden almacenar carga una vez desconectado el equipo. Aunque la energía almacenada está dentro de los requisitos de seguridad, pudiera sentirse una ligera descarga al tocar la clavija de alimentación inmediatamente después de su desconexión de red.

No retire las cubiertas del chasis del instrumento, ya que pudiera resultar dañado personalmente. No existen partes que puedan ser reparadas en su interior.

Deje todas las tareas relativas a reparación a un servicio técnico cualificado. Vea la lista de Centros de Servicios Internacionales en la parte trasera del manual.

Fusibles

Se hace notar que el Equipo está dotado de fusibles tanto en el activo como el neutro de alimentación. Si sólo uno de estos fusibles fundiera, existen partes del equipo que pudieran permanecer a tensión de red.

WARNING



Peligro de incendio

Asegúrese de utilizar sólo fusibles del tipo y valores especificados como repuesto.

Si se utiliza una clavija con fusible incorporado, asegúrese de que los valores del fusible corresponden a los requeridos por el equipo. Consulte la Hoja Técnica (tras el Capítulo 1) para comprobar los requisitos de alimentación.

WARNING**Aviso de toxicidad**

Alguno de los componentes utilizados en este equipo pudieran incluir resinas u otro tipo de materiales que al arder produjeran sustancias tóxicas, Por tanto, tome las debidas precauciones en la manipulación de esas piezas.

WARNING**Berilio-cobre**

Algunos componentes mecánicos contenidos en este instrumento incorporan berilio-cobre en su proceso de fabricación. Se trata de una aleación con un contenido aproximado de berilio del 5%, lo que no representa ningún riesgo durante su uso normal.

El material no debe ser manipulado, soldado, ni sometido a ningún proceso que implique la aplicación de calor.

Para su eliminación debe tratarse como un "residuo especial". El material NO DEBE eliminarse mediante incineración.

WARNING**Litio**

En este equipo se utiliza una batería de litio (o contenida dentro de un CI).

Dada que el litio es una substancia tóxica las baterías de este material no deben ser aplastadas, quemadas o arrojadas junto a basuras ordinarias.

No trate de recargar este tipo de baterías. No las cortocircuite o fuerce su descarga ya que puede dar lugar a que la esta emita gases, se recaliente o explote.

WARNING



Tener en cuenta con el equipo inclinado

Si utiliza el equipo en posición inclinada, se recomienda, por razones de estabilidad, no apilar otros equipos encima de él.

CAUTION

Idoneidad de uso

Este equipo ha sido diseñado y fabricado por Aeroflex para realizar medidas en RF y microondas en componentes y sistemas

Si el equipo fuese utilizado de forma diferente a la especificada por Aeroflex, la protección ofrecida por el equipo pudiera quedar reducida.

Aeroflex no tiene control sobre el uso de este equipo y no puede, por tanto, exigirsele responsabilidades derivadas de una utilización distinta de aquellas para las que ha sido diseñado.

Aeroflex Warranty

Aeroflex will repair this equipment free of charge if a malfunction occurs within 2 year after shipment due to a manufacturing fault, provided that warranty is rendered void under any or all of the following conditions.

- The fault is outside the scope of the warranty conditions described in the operation manual.
- The fault is due to wrong operation, misuse, or unauthorized modification or repair of the equipment by the customer.
- The fault is due to severe usage clearly exceeding normal usage.
- The fault is due to improper or insufficient maintenance by the customer.
- The fault is due to natural disaster including fire, flooding and earthquake, etc.
- The fault is due to use of non-specified peripheral equipment, peripheral parts, consumables, etc.
- The fault is due to use of non specified power supply or in non-specified installation location.

In addition, this warranty is valid only for the original equipment purchaser. It is not transferable if the equipment is resold.

Aeroflex will not accept liability for equipment faults due to unforeseen and unusual circumstances, nor for faults due to mishandling by the customer.

Aeroflex Contact

If this equipment develops a fault, contact office of Aeroflex at the address in the operation manual, or your nearest sales or service office.

Front Panel Power Switch

If the equipment is in the standby state, the front power switch of this equipment turns on the power when it is pressed.

If the switch is pressed continuously for about 1 second in the power off state, the equipment enters the standby state to prevent malfunction caused by accidental touching.

In the power on state, if the power plug is removed from the outlet, then reinserted, the power will not be turned on. Also, if the line is disconnected due to momentary power supply interruption or power failure, the power will not be turned on even when power is restored.

This is to prevent incorrect data from being acquired when the line is disconnected and reconnected.

For example, if the sweep is 1,000 seconds and data acquisition requires a long time, momentary power supply interruption (power failure) might occur during measurement and the line could be recovered automatically to power on. In such a case, the equipment may mistake incorrect data for correct data without recognizing the momentary power supply interruption.

If this equipment enters the standby state due to momentary power supply interruption or power failure, check the state of the measuring system and press the front power switch to restore power to this equipment.

Further, if this equipment is built into a system and the system power has to be disconnected then reconnected, the power for this equipment must also be restored by pressing the front power switch.

DETECTION MODE

This equipment is a spectrum analyzer, which uses a digital storage system. The spectrum analyzer makes level measurements in frequency steps obtained by dividing the frequency span by the number of measurement data points (500). Because of this operation it is desired to use the following detector modes associated with the appropriate measurements.

Measurement	Detector mode
○ Normal signal	POS PEAK
○ Random noise	SAMPLE OR AVERAGE
○ Pulsed noise	NORMAL
○ Occupied frequency bandwidth	SAMPLE
(for analog communication systems)	
○ Occupied frequency bandwidth	POS PEAK or SAMPLE
(for digital communication systems)	

When a detection mode is specified as one of the measurement methods, make the measurement in the specified detection mode.

ABOUT THIS MANUAL

Composition of 2394A/2395A Manuals

The 2394A/2395A Spectrum Analyzer manuals of the standard type are composed of the following three parts.

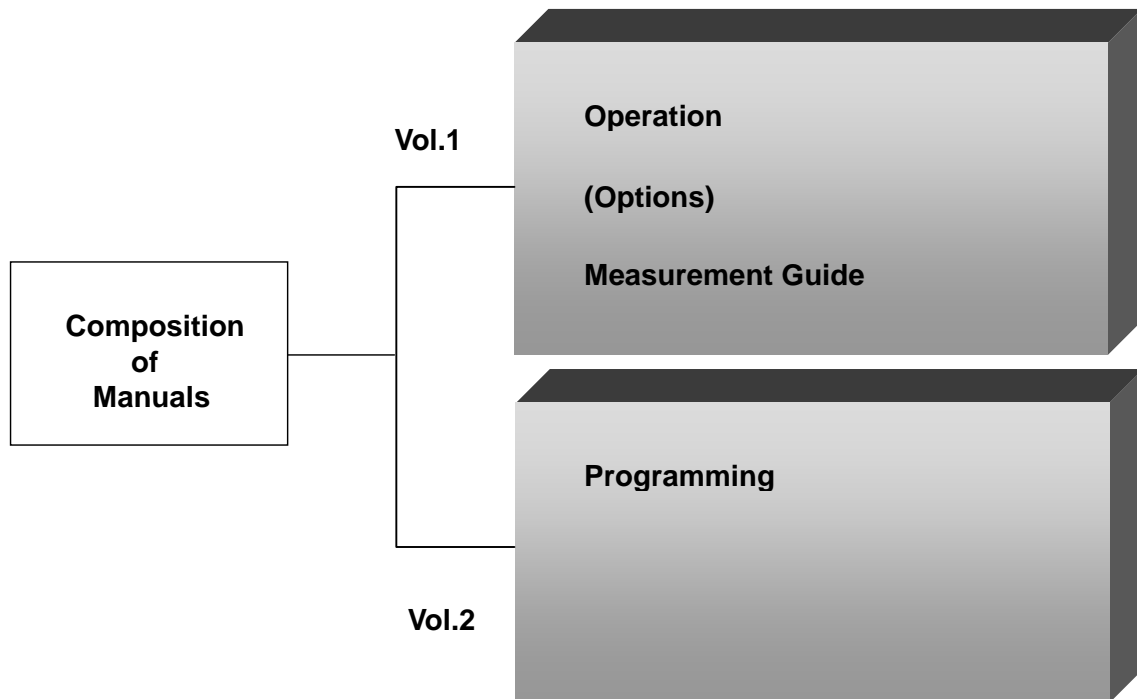

Operation Manual : Provides information on the 2394A/2395A outline.
Preparation before use, panel description,
Operation procedure, soft-key menu and performance tests.

Measurement Guide : Provides basic measurements with examples of typical measurements.

Programming Manual : Provides information on RS-232C remote control, GPIB remote control and sample programs.

COMPOSITION OF OPERATION MANUAL

This Manual is composed of 7 sections. The profile of each section is shown below.

Section Composition	Explanation
SECTION 1 GENERAL	Product outline, options, applicable parts, peripheral devices, and specifications
SECTION 2 PREPARATIONS BEFORE USE	Operations to be accomplished before applying power
SECTION 3 PANEL DESCRIPTION	Description of the front and rear panels
SECTION 4 MENU TREE	Description of the soft-key menu
SECTION 5 OPERATION PROCEDURES	Operation procedures for operation guide
SECTION 6 PERFORMANCE TESTS	Tests used for checking performance
SECTION 7 STORAGE AND TRANSPORTATION	Cautions on storage and transportation

TABLE OF CONTENTS

Safety Symbols & For Symbols	2
ABOUT THIS MANUAL	10
COMPOSITION OF OPERATION MANUAL	11
SECTION 1 GENERAL	1-1
PRODUCT OUTLINE	1-3
EQUIPMENT CONFIGURATION	1-4
Options	1-4
SPECIFICATIONS	1-5
SECTION 2 PREPARATIONS BEFORE USE	2-1
INSTALLATION SITE AND ENVIRONMENTAL CONDITIONS	2-3
-	2-3
Locations to Be Avoided	2-4
SAFETY MEASURES	2-4
Power On	2-5
Input Level to RF Input	2-6
PREPARATIONS BEFORE POWER ON	2-7
Protective Grounding	2-8
Replacing Fuse	
	3-1
SECTION 3 PANEL DESCRIPTION	3-3
TABLE OF FRONT AND REAR PANEL FEATURES	3-8
TABLE OF I/O CONNECTORS	3-9
GPIB CONNECTOR	3-10
RS-232C CONNECTOR	3-11
PRINTER CONNECTOR	3-12
EXT VGA CONNECTOR	3-13
PROBE POWER CONNECTOR	
	4-1
SECTION 4 MENU TREE	4-4
MENU TREE	4-4
FREQ, SPAN, AMPL	4-5
MEAS	4-6

MKR, FC -----	4-7
MKR > , PEAK -----	4-8
TRIG, CPL -----	4-9
DISP -----	4-10
TRACE -----	4-11
FILE -----	4-12
LIMIT, SYSTEM -----	4-13
PRESET, AUX -----	4-13
SECTION 5 OPERATING PROCEDURES -----	5-1
SCREEN LAYOUT -----	5-6
ANNOTATION WINDOW -----	5-7
FREQ/SPAN FUNCTIONS -----	5-7
Center-Span Mode Frequency Data Entry -----	5-8
Start-Stop Mode Frequency Data Entry -----	5-9
Setting Center Frequency Step -----	5-10
Setting Frequency Offset -----	5-10
Setting Full Span -----	5-11
Setting Zero Span -----	5-11
Return to the Previous Span -----	5-11
Zoom In/Zoom Out -----	5-12
10 MHz Ref. -----	5-13
AMPLITUDE FUNCTIONS -----	5-13
Setting Reference Level -----	5-13
Selecting Log/Linear Detector Mode -----	5-14
Setting Amplitude Scale -----	5-14
Setting Amplitude Units -----	5-15
Setting Input Attenuation -----	5-15
Selecting Input Impedance -----	5-16
Setting the Reference Level Offset -----	5-16
Setting Internal Amp -----	5-16
Setting Calibration Signal Output -----	5-17
MEASUREMENT FUNCTIONS -----	5-17
X dB Down Measurement -----	5-18
Adjacent Channel Power Measurement -----	5-18
Channel Power Measurement -----	5-19
Occupied Bandwidth Measurement -----	5-20
Harmonic Distortion Measurement -----	5-21
Clear Measurement -----	5-21
Continue Measurement -----	5-21

Quasi-Peak (option) -----	5-22
MARKER FUNCTIONS -----	5-22
Selecting & Changing Marker Position -----	5-23
Normal Marker -----	5-23
Delta Marker -----	5-24
Marker Off by Reverse Step -----	5-24
Setting the MKR Trace -----	5-25
Setting the Marker Readout Mode -----	5-26
Setting the Marker Function -----	5-26
Setting the Marker Table -----	5-27
Off All Marker -----	5-27
Frequency Counter -----	5-28
SETTING PARAMETERS USING MARKER VALUES -----	5-28
MKR > CF / MKR > Ref -----	5-28
MKR > Start / MKR > Stop -----	5-29
Mkr > CFstep / dMkr > CFstep -----	5-29
dMkr > Span -----	5-29
Mkr > ZoomIN / Mkr > ZoomOUT -----	5-30
PEAK SEARCH FUNCTIONS -----	5-30
Peak Search -----	5-30
Next Peak Search -----	5-31
Peak Left Search/Peak Right Search -----	5-31
Marker Track -----	5-31
Peak to Peak Search -----	5-32
Setting the Search Parameters -----	5-33
TRIGGER FUNCTIONS -----	5-33
Continuous Sweep Mode -----	5-33
Single Sweep Mode -----	5-34
Trigger Source -----	5-34
Video Trigger -----	5-35
Line Trigger -----	5-35
External Trigger -----	5-35
Trigger Delay -----	5-36
Select Trigger Edge -----	5-36
Time Gate -----	5-37
Time Gate Menu -----	5-38
COUPLED FUNCTIONS -----	5-38
All Auto Function -----	5-39
Setting the Resolution Bandwidth(RBW) -----	5-40
Setting the Video Bandwidth(VBW) -----	5-41

Setting the Sweep Time -----	5-41
Input Attenuator -----	5-43
DISPLAY FUNCTIONS -----	5-43
Display Line -----	5-44
Threshold Line -----	5-44
Screen Title -----	5-46
Graticule -----	5-46
Annotation -----	5-46
White Mode -----	5-47
TRACE FUNCTIONS -----	5-47
Select Trace -----	5-47
Clr & Wrt -----	5-47
Max Hold -----	5-48
Min Hold -----	5-48
View -----	5-48
Blank -----	5-49
Averaging Function -----	5-50
Detection Mode -----	5-51
Mathematics Mode -----	5-52
SAVE AND FILE FUNCTIONS -----	5-52
Internal Memory -----	5-52
Save Parameters and Waveform -----	5-53
File Management -----	5-56
LIMIT LINE FUNCTIONS -----	5-58
SYSTEM CONFIGURATION -----	5-58
Printer Configuration -----	5-59
Clock Set -----	5-59
GPIB Address Set -----	5-60
RS-232C Configuration -----	5-61
System Information -----	5-62
PRESET FUNCTIONS -----	5-62
Preset -----	5-63
Last State -----	5-63
Alignment Mode -----	5-64
Power ON -----	5-64
Auto Align -----	5-65
AUX FUNCTIONS -----	5-65
AM Demodulation -----	5-65
FM Demodulation -----	5-66
Audio Monitor -----	5-67

AUTO TUNE -----	6-1
SECTION 6 PERFORMANCE TESTS -----	6-3
REQUIREMENT FOR PERFORMANCE TESTS -----	6-4
INSTRUMENTS REQUIRED FOR PERFORMANCE TEST -----	6-6
PERFORMANCE TEST -----	6-6
Reference Oscillator Frequency Stability -----	6-8
Center Frequency Readout Accuracy -----	6-11
Frequency Span Readout Accuracy -----	6-14
Resolution Bandwidth(RBW) and Selectivity and Switching Error --	6-22
Sideband Noise (Phase noise) -----	6-24
Frequency Measurement Accuracy -----	6-26
Amplitude Display Linearity -----	6-34
Frequency Response -----	6-37
Reference Level Accuracy -----	6-40
Average Noise Level -----	6-43
Second Harmonic Distortion -----	6-45
Input Attenuator Switching Error -----	6-48
Residual FM -----	6-50
3 rd Order Intermodulation -----	6-53
Spurious Response -----	6-55
Local Oscillator Emission -----	6-57
Input VSWR -----	7-1
SECTION 7 STORAGE AND TRANSPORTATION -----	7-3
CLEANING -----	7-4
STORAGE PRECAUTIONS -----	7-4
Precautions Before Storage -----	7-4
Recommended Storage Precautions -----	7-5
REPACKING AND TRANSPORTATION -----	7-5
Repacking -----	7-5
Transportation -----	7-6
SERVICE -----	

SECTION 1 GENERAL

This section outlines the 2394A/2395A (henceforth called “Equipment”) and explains the composition of this manual, the configuration of the equipment with the options, the optional accessories, peripherals for expanding the equipment capabilities, and the equipment specifications.

TABLE OF CONTENTS

PRODUCT OUTLINE -----	1-3
EQUIPMENT CONFIGURATION -----	1-4
Options -----	1-4
SPECIFICATIONS -----	1-5

<BLANK>

SECTION 1 GENERAL

PRODUCT OUTLINE

The equipment is a portable type spectrum analyzer suited for signal analysis of radio equipment where the efficiency of frequency usage is increased and equipment is increasingly speeded and digitized.

The equipment adopts the synthesizer local system and can cover all frequencies from 9kHz to 13.2GHz (2394A) / 26.5GHz (2395A) excellent in basic performance such as distortion, frequency/level accuracy, and easy operation, by following the display of the soft-key menu screen.

Excellent cost performance with rich options to cope with various applications.

Equipped with high accuracy calibration signals and an attenuator, it can accurately calibrate switching errors of LOG/LIN scales, resolution bandwidth, reference level, etc.

Since frequency response data is corrected by built in calibration data, allowing high-accuracy level measurement for a wide range.

This unit provides the MEASURE function that can perform measurement of various applications without requiring the intervention of external controllers. Therefore, the performance evaluation of radio equipment can be easily done in terms of frequency, noise, occupied frequency bandwidth, etc.

■ Application

This unit is useful for the production, building and maintenance of electronic equipment and devices for the following.

- AM/FM radio equipment
- Digital cellular telephone/cordless telephone
- Satellite broadcasting and TV equipment
- Small capacity microwave equipment

EQUIPMENT CONFIGURATION

This paragraph describes the configuration of the equipment with the various options to expand the functions.

Options

The table below shows the options for the equipment which are sold separately.

Model No.	Name	Remarks
Option 3	High Stability Oscillator	Stability : $\leq \pm 0.2\text{ppm}$
Option 4	Quasi-Peak Detector	QP B QP C/D
Option 5	Digital RBW	10, 30, 100Hz RBW
Option 12	Marker Editor	Marker name editor
Option 13	EMC Measurement Package (Firmware)	Quasi-Peak included. Support Log X scale display. Limit/X-ducer/Cable/Ant/Others Parameter file management. Limit line link with graticule.

※ Please specify the model number, name, and quantity when ordering.

SPECIFICATIONS

NOTE : A fifteen minute warm up time shall apply.

1. **Electrical Specifications**
2. **General Characteristics**
3. **Environmental Specifications**
4. **Safety & EMC Specifications**

1. Electrical Specifications

1.0 Frequency

1.1 Frequency Range : 9kHz to 13.2GHz (2394A)

Range	Band	LO Harmonics
9kHz to 3GHz	0	1
2.9GHz to 6.4GHz	1	1
6.3GHz to 13.2GHz	2	2

Frequency Range : 9kHz to 26.5GHz (2395A)

Range	Band	LO Harmonics
9kHz to 3GHz	0	1
2.9GHz to 6.4GHz	1	1
6.3GHz to 13.2GHz	2	2
12.9GHz to 26.5GHz	3	4

1.2 Frequency Accuracy : SPAN x SPAN ACCURACY \pm 0.5 x RBW

1.3 Frequency Counter

1.3.1 Accuracy : $\pm(\text{Reference frequency error} \times \text{Marker Frequency accuracy}$
 $+ \text{Counter Resolution} \pm 1 \text{ LSB})$

1.3.2 Resolution : 1Hz, 10Hz, 100Hz, 1kHz

1.3.3 Sensitivity : -70 dBm min

1.4 Frequency SPAN

1.4.1 Range : 10 Hz/Div to FULL SPAN,
ZERO SPAN

1.4.2 Accuracy : $\leq \pm 3\%$

1.5 Stability

1.5.1 Residual FM : $\leq 100\text{Hzp-p}$ in 200 ms @ 1kHz RBW ,1kHz VBW

1.5.2 Noise Sidebands : $\leq -90\text{dBc/Hz} + 20\log N$ for Frequency 3.0GHz @ 10kHz offset

N = LO Harmonic mixing Mode

1.6 Frequency Ref. Accuracy

1.6.1 Long Term Drift : $\leq \pm 1 \text{ ppm/yr}$

$\leq \pm 0.1 \text{ ppm/yr}$ (option : High Stability Oscillator)

1.6.2 Short Term Drift : $\leq \pm 2$ ppm over temperature range

$\leq \pm 0.2$ ppm (option : High Stability Oscillator)

2.0 Amplitude

2.1 Measurement : +30 dBm to -110 dBm

2.2 Average Displayed Noise Level : [RBW : 300 Hz , VBW : 10 Hz]

≤ -105 dBm, 50 kHz to 100kHz

≤ -110 dBm, 100kHz to 2.8GHz

≤ -105 dBm, 2.8GHz to 3.0GHz

≤ -115 dBm, 3.0GHz to 13.2GHz (2394A)

≤ -110 dBm, 3.0GHz to 13.2GHz (2395A)

≤ -100 dBm, 13.2GHz to 26.5GHz (2395A)

2.3 1dB Compression Point : -10dBm @ Input ATT 0 dB

2.4 Displayed Range : 100 dB in 10 dB/div log scale
50 dB in 5 dB/div log scale
20 dB in 2 dB/div log scale
10 dB in 1 dB/div log scale
10 divisions with Linear scale

2.5 Amplitude Units

2.5.1 LOG Display Mode : dBm, dBmV, dBuV, Volts, Watts

2.5.2 LINEAR Display Mode : V(mV, uV) , dBmV

2.6 Display Linearity

LOG : $\leq \pm 1.0$ dB over 10 divisions (5 or 10dB/div)

$\leq \pm 0.5$ dB over 10 divisions (1 or 2dB/div)

LINEAR : $\leq \pm 3\%$ of Ref. Level over 10 divisions

2.7 Flatness over frequency : $\leq -3.0 \sim +1$ dB, 9 kHz to 5 MHz

$\leq \pm 1.0$ dB, 5 MHz to 2.9 GHz

$\leq \pm 1.5$ dB, 3.0 GHz to 6.4 GHz

$\leq \pm 2.2$ dB 6.4 GHz to 13.2 GHz

$\leq \pm 3.0$ dB 13.2 GHz to 26.5 GHz

@ 10dB RF attenuation, room temperature (15°C ~ 30°C)

2.8 Attenuator

2.8.1 Range : 0 to 55 dB (Manual or Auto)

2.8.2 Resolution : 5 dB steps

2.8.3 Accuracy : ± 0.5 dB by steps,
 ± 1 dB full steps

2.9 Reference Level

2.9.1 Range : +30 dBm to -110 dBm

2.9.2 Resolution : 0.1 dB step Minimum

2.9.3 Accuracy : ± 1.0 dB (50 kHz to 13.2 GHz)

2.10 Residual Spurious : \leq -85 dBm (Input terminated , 0 dB attenuator)

2.11 Harmonic Distortion : \leq -60 dBc , -30 dBm input (0 dB Attenuator)

2.12 Intermodulation Distortion : \leq -70 dBc , 100 MHz to 26.5 GHz

(-30 dBm input, 0 dB attenuation)

\leq -65 dBc , 10 MHz to 100 MHz

(-30 dBm input, 0 dB attenuation)

2.13 Other Input Related Spurious : \leq -60 dBc , -30 dBm input

2.14 Resolution Bandwidth

- 2.14.1 Selections : 300Hz to 3MHz (1-3-10 steps),
9kHz, 120kHz (for Quasi Peak Detection Option)
10Hz, 30Hz, 100Hz (for Digital RBW Option)
- 2.14.2 Accuracy : $\leq \pm 20\%$
- 2.14.3 Selectivity : 60 dB / 3 dB < 15:1
60 dB / 6 dB < 12:1 (9kHz, 120kHz)
- 2.14.4 Switching Error : $\leq \pm 1.0$ dB refer to 3 kHz RBW

2.15 Video Filter

- 2.15.1 Selections : 1 Hz to 1 MHz (1-3-10 steps plus None)
- 2.15.2 Accuracy : $\leq \pm 20\%$

3.0 Sweep

- 3.1 Rate : 20 ms to 1000s
5 ms to 15 s @ ZERO SPAN
25 us to 2 ms @ Fast ZERO SPAN
Auto coupled with SPAN, RBW, VBW

3.2 Accuracy : $\leq 20\%$ @ less than 100 ms

3.3 Trigger

3.3.1 Source : FREE RUN, VIDEO, LINE, EXT

3.3.2 Mode : Single , Continuous

4.0 Display

4.1 Type : 6.4" VGA TFT LCD

4.2 Resolution : 640 H X 480 V

5.0 Inputs

5.1 RF Input

5.1.1 Connector : Type N Female, 50 ohm nominal (2394A)

Type N Female, or Type 2.92mm Female (2395A)

5.1.2 VSWR : $\leq 2.0 : 1$ (Type 2.92mm Female @ 10 dB ATT)

5.1.3 Max Input Level : ± 50 VDC, +30 dBm @ 10dB ATT

5.1.4 LO Emission : ≤ -70 dBm @ 0dB ATT

6.0 Outputs

- 6.1 IF Output : 10.7 MHz swept signal
- 6.2 Video Output : 0 ~ 5VDC (TTL level)
- 6.3 Cal Signal Output : 20MHz , -20dBm \pm 0.3dB @ 50 Ω Impedance
- 6.4 SWP Gate Output : 0 ~ 5VDC (TTL level)
- 6.5 Power Probe : 3 Pin connector (+15VDC, -12 VDC, GND)

- 7.0 Memory : 16 Mbytes (size of memory)

8.0 AM Demodulation

- 8.1 Demodulation Range : 5% to 90% @ 1KHz, 50% modulation, -20dBm Input
- 8.2 Input Level Range : -2.0dBm to -75dBm @ 1KHz, 50% modulation
- 8.3 Frequency Response: 20Hz to 30KHz @ -20dBm Input
- 8.4 Distortion : \leq 5% @ 90% modulation @ 1KHz , -20dBm Input
 \leq 2% @ 50% modulation @ 1KHz , -20dBm Input

9.0 FM Demodulation

9.1 Deviation Range : $\leq 80\text{KHz}$

9.2 Input Level Range : -2.0dBm to -75dBm @ 50KHz deviation

9.3 Frequency Response : 20Hz to 100KHz @ -20dBm Input

9.4 Distortion : $\leq 5\%$ @ 20KHz deviation @ 1KHz , -20dBm Input
 $\leq 2\%$ @ 50% modulation @ 1KHz , -20dBm Input

10.0 External Trigger Input

10.1 Connector : BNC female, Rear Panel

10.2 Impedance : 10 kohm (nominal) , dc coupled

10.3 Trigger Level : TTL Level

10.4 Trigger Delay

Pre-trigger : Range : - Time Span to 0 sec

Resolution : Time Span / 500

Post-trigger : Range : 0 sec to + Time Span

Resolution : Time Span / 500

11.0 RS-232C Interface

11.1 Type : Null Modem

11.2 Baud Rate : 600bps, 1200bps, 2400bps, 4800bps, 9600bps, 19200bps
38400bps, 57600bps, 115200bps

11.3 Data Length : 7bits, 8bits

11.4 Stop Bit : 1bit, 2bit

11.5 Parity Bit : None, Even, Odd, Mark, Space

12.0 GPIB Interface

12.1 Interface : SH1, AH1, T5, L3, SR1, RL1, PP1, DC1, DT1, C0, PP0
SR0, DC0, DT0, C1, C2, C3

12.2 Specifications : IEEE488.2
Can be controlled as device from external Host Controller

13.0 External Reference: Switchable between Internal / External

13.1 Frequency : 10MHz

13.2 Level : -5 dBm to +15 dBm (@ Input Level)

+5 dBm (@ Output Level)

13.3 Connector : BNC female

14.0 Printer

14.1 Type : HP-LaserJet

14.2 Function : Output data to printer

14.3 Connector : D-sub, 25 pin

2. General Characteristics

1.0 Dimensions : 150mm x 320mm x 330mm

2.0 Weight : 11.4 Kg (2394A, without option)

11.8 Kg (2395A, without option)

3.0 Power Requirements (standard)

3.1 Source Voltage and Frequency : 100VAC to 240VAC, 50/60Hz

3.2 Power Consumption : 100 Watts Maximum (without option)

3.3 Fuse Requirements : 3.15A, 250V, Type2, 2EA

4.0 Warm-up Time : 15 minutes

3. Environmental Specifications

1.0 Temperature Range

1.1 Storage : -20°C to +60°C

1.2 Operating : 0°C to +40°C

2.0 Humidity

2.1 Spec : Non-condensing (80% storage)

3.0 Shock & Vibration

3.1 Spec : MIL-T-28800E , type 2 , CLASS 5

4.0 Altitude : Operation up to 3000 meters

Non-Operating up to 40000 feet

4. Safety & EMC Specifications

1.0 Safety : EN61010-1 : 2001

1.1 Main Supply Voltage Fluctuations : Nominal Voltage $\pm 10\%$

1.2 Transient Overvoltage : Installation Category II

1.3 Pollution Degree : 2

2.0 EMC

2.1 RF emissions : EN55011 : 1998+A1:1999+A2:2002 Group 1 Class A

2.2 RF immunity : EN61326 : 1997+A1:1998+A2:2001+A3:2003

SECTION 2 PREPARATIONS BEFORE USE

This section explains the preparations and safety procedures that should be performed before using the equipment. The safety procedures are to prevent the risk of injury to the operator and damage to the equipment.

Ensure that you understand the contents of the pre-operation preparations before using the equipment.

For connecting the GPIB cable and setting the GPIB address, see the remote control operation in Programming Manual.

TABLE OF CONTENTS

INSTALLATION SITE AND ENVIRONMENTAL CONDITIONS -----	
Locations to Be Avoided -----	2-3
SAFETY MEASURES -----	2-3
Power On -----	2-4
Input Level to RF Input -----	2-4
PREPARATIONS BEFORE POWER ON -----	2-5
Protective Grounding -----	2-6
Replacing Fuse -----	2-7
	2-8

<BLANK>

SECTION 2 PREPARATIONS BEFORE USE

INSTALLATION SITE AND ENVIRONMENTAL CONDITIONS

Locations to Be Avoided

The equipment operates normally at temperatures from 0 to 40°C. However, for best performance, the following situations should be avoided.

- Where there is severe vibration.
- Where the humidity is high.
- Where the equipment will be exposed to direct sunlight.
- Where the equipment will be exposed to active gases.

In addition to meeting the above conditions, to ensure long term trouble free operation, the equipment should be used at room temperature and in a location where the power supply voltage does not fluctuate greatly.

CAUTION 

If the equipment is used at normal temperatures after it has been used or stored for a long time low temperatures, there is a risk of short circuiting caused by condensation.

To prevent this risk, do not turn the equipment on until it has been allowed to dry out sufficiently.

To suppress any internal temperature increase, the equipment has a fan on the rear panel. As shown in the diagram below, leave a gap of at least 10 cm between the rear panel and wall, nearby equipment or obstructions so that fan ventilation is not blocked.

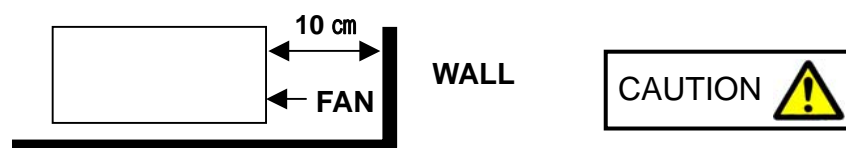

SAFETY MEASURES

This paragraph explains the safety procedures, which should be followed under all circumstances to prevent the risk of an accidental electric shock, damage to the equipment or a major operation interruption.

Power On



- Before Power on

The equipment must be connected to protective ground.
If the power is switched on without taking this precaution, there is a risk of receiving an accidental electric shock.
In addition, it is essential to check the power source voltage.
If an abnormal voltage that exceeds the specified value is input, there is accidental risk of damage to the equipment and fire.

In the following, special notes on safety procedures are extracted from sections other than section 2.

To prevent accidents, read this section together with the related sections before beginning operation.

Input Level to RF Input

Frequency range : 9kHz to 13.2GHz (2394A)
9kHz to 26.5GHz (2395A)

Measurement level : The maximum signal level that can be applied to the RF input connector is +30 dBm.

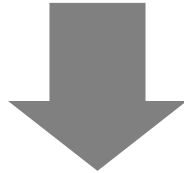

WARNING



The RF Input circuit is not protected against excessive power.

If a signal exceeding +30 dBm is applied, the input attenuator and internal circuit will be damaged.



Do not input over ± 50 VDC to the RF input connector

PREPARATIONS BEFORE POWER ON

The equipment operates normally when it is connected to an 100 VAC to 250 VAC (automatic voltage selected automatically) 50/60 Hz AC power supply. To prevent the following, take the necessary procedures described on the following pages before power is supplied.

- Accidental electric shock.
- Damage caused by abnormal voltage.
- Ground current problems.

To protect the operator, the following WARNING and CAUTION notices are attached to the rear panel of the equipment.

WARNING 

**TO AVOID ELECTRIC SHOCK,
THE PROTECTIVE GROUNDING CONDUCTOR
MUST BE CONNECTED TO GROUND.
DO NOT REMOVE COVERS.
REFER SERVICING TO QUALIFIED
PERSONNEL.**

CAUTION 

**FOR CONTINUED FIRE
PROTECTION
REPLACE ONLY WITH SPECIFIED
TYPE AND RATED FUSE.**

WARNING 

Disassembly, adjustment, maintenance, or other access inside this equipment is to be performed qualified personnel only. Maintenance of this equipment should be performed only by trained service personnel who are familiar with the risk involved of fire and electric shock. Potentially lethal voltages existing inside this equipment, if contacted accidentally, may result in personal injury or death, or in the possibility of damage to precision components.

Always follow the instructions on the following pages.

Protective Grounding

Grounding with frame ground (FG) terminal

When there is no grounded AC power-supply outlet, the protective frame ground (FG) terminal on the rear panel must be connected directly to ground potential.

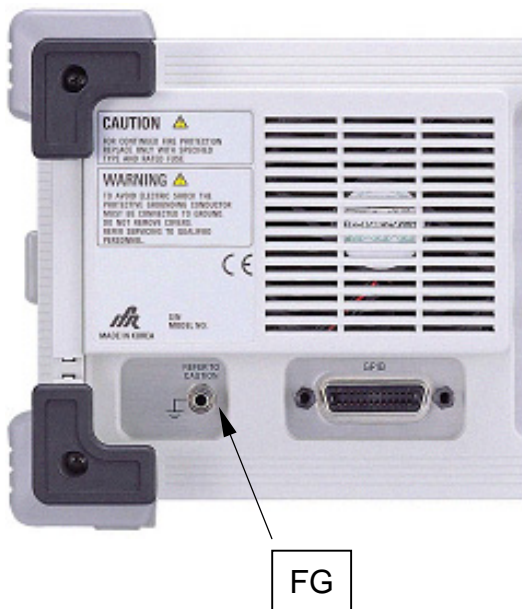

WARNING 

If power is applied without protective grounding, there is a risk of accidental electric shock. The protective frame ground (FG) terminal on the rear frame, or the ground pin of the supplied power cord must be connected to ground potential before power is supplied to the equipment.

Replacing Fuse

WARNING



- If the fuses are replaced while power is supplied, there is a serious risk of electric shock. Before replacing the fuses, set the power switch to OFF and remove the power cord from the power outlet.
 - If power is supplied without protective grounding, there is a risk of accidental electric shock. In addition, if the AC power supply voltage is excessive, there is a risk of the internal circuits of the equipment being damaged by the abnormal voltage. Before supplying power again after changing the fuses, check that the protective grounding described previously is still connected, and check that the AC power supply voltage is suitable. Then, set the power switch to ON.
-

CAUTION



When there are no supplied spare fuses, the replacement fuses must have the same voltage and current rating as specified.

- If the replacement fuses are not of the same type, they may not fit correctly, there may be a faulty connection, or the time for the fuses to blow may be too long.
 - If the voltage and current rating of the fuses is incorrect, the fuse may not blow causing damage to the equipment.
-

The fuses are inserted in the fuse holder and must be replaced if they blow. If the fuses must be replaced, locate and remedy the cause before replacing the blown fuses. The equipment, with standard accessories, has two spare T3.15A fuses.

After performing the safety procedures described on the preceding page, replace the fuses according to the following procedure.



Step	Procedure
1	Set the front panel [Power] switch to STBY and the rear panel [Line] switch to OFF. Then, remove the power cord from the power-supply outlet.
2	Pull out the fuse holder at the rear panel with pressing the fuse holder hook.
3	Remove the fuse from the fuse cap and replace it with a spare fuse. (The direction does not matter.)
4	Put the fuse cap with fuse into the fuse holder and insert it by pushing inward.

SECTION 3 PANEL DESCRIPTION

In this section the front and rear panels are described.

TABLE OF CONTENTS

TABLE OF FRONT AND REAR PANEL FEATURES -----	3-3
TABLE OF I/O CONNECTORS -----	3-8
GPIB CONNECTOR -----	3-9
RS-232C CONNECTOR -----	3-10
PRINTER CONNECTOR -----	3-11
EXT VGA CONNECTOR -----	3-12
PROBE POWER CONNECTOR -----	3-13

<BLANK>

SECTION 3 PANEL DESCRIPTION

In this section, the front and rear panels are described.

- Fig. 3-1 Front panel
- Fig. 3-2 Rear panel

This manual express the key on the front panel, call it a hard key, as boxed letter. And the key of menu(F1 ~ F7), call it a soft key, is expressed as italic.

Example] FREQ *Center*

TABLE OF FRONT AND REAR PANEL FEATURES

NO	Panel Marking	Explanation of Function
①	(LCD)	This is liquid crystal display. It display the trace waveforms, the parameter settings, the value of marker, and the soft menu keys, etc.
②	F1 ~ F7	These are the soft keys for selecting the soft key menus linked to the panel key operation.
③	FUNCTION FREQ SPAN AMPL MEAS	This is the frequency parameter data input section. This is the span parameter data input section. This is the amplitude parameter data input section. This key sets the measurement functions.
④	MARKER MKR FC MKR > PEAK	This key sets marker. This key function is the frequency counter. This key is the marker shift function. This key is related the peak search function.

NO	Panel Marking	Explanation of Function
⑤	CONTROL	
	TRIG	This sets the trigger functions.
	CPL	This set the RBW, VBW, sweep time.
	DISP	This key sets the display functions.
	TRACE	This section is for selection the trace waveform, detection mode and video average mode.
⑥	SYSTEM	
	SAVE	This key is used for saving the waveforms status, and limit lines.
	FILE	This key is used for recalling the waveforms, status, and limit lines.
	LIMIT	This key sets the limit line functions.
	SYSTEM	This key sets the configuration of system.
	PRESET	This sets the measurement parameters to the default values. Also calibration menus are include under this key.
	AUX	This key sets the auxiliary functions, such as FM/AM demodulation, audio control and squelch control.
	TUNE	This key is used for auto tuning function.
	PRINT	This key is used for printing.
	⑦	(USB Port)
⑧	(SCROLL	This key is used for scrolling the parameters.
⑨	Knob)	These keys are used for up/down the parameters.
⑩	(STEP KEY)	This is the RF input connector.
⑪	RF INPUT	This is for RF probe power.
⑫	PROBE	These keys set the numeric data, units, and special functions.
	DATA ENTRY	[\wedge , \vee] Increment and decrement input data. [0...9, +/-, BS, ENTER] Numeric data setting key
⑬		This is a output connector for earphone.
⑭	PHONE	This is the calibration signal output connector.
⑮	CAL. OUT	This key is used for keyboard, but reserved for other function.
	KEYBOARD	(Only for system calibration and maintenance)

-
- ①⑥ STBY/ON This is the power switch. It can be used when the back panel power switch is on. The power on condition is fetched from the STBY condition when the key is pressed momentary. The equipment is returned to the STBY condition from the power on condition when the key is pressed again for about 1 seconds.
- ①⑦ IF OUT This is the IF output connector, This signal is band-width controlled by the RBW setting
- ①⑧ VIDEO This is an output connector.
- ①⑨ EXT TRIG This is an input connector for the external trigger.
- ②⑩ RS-232C This is the RS-232C connector. Connect it to system controller.
- ②⑪ EXT VGA This is VGA output for external monitor.
- ②⑫ (OFF/ON) This is the fused AC power switch.
- (Inlet) This is the fused AC power inlet to which the supplied power cord is connected.
- (Fuse Holder) It contains two lag fuses.
- ②⑬ PRINTER This is for use with the printer.
- ②⑭ SWP GATE This is an output connector for sweep gate signal.
- ②⑮ REF I/O This is the input/output connector for an external reference crystal oscillator. When the external reference signal input to this connector, user turns this port on from the front panel. An indication is supplied at the bottom of the screen.
- 10.0 MHz
- ②⑯ GPIB This is for use with the GPIB interface. It is the connector to an external system controller. (If option is not attached, this is not provided.)
- ②⑰ (FAN) This is the cooling fan ventilating internally generated heat. Leave a clearance of a 10 cm around the fan.
- ②⑱ (FG) This is the frame ground terminal.
-

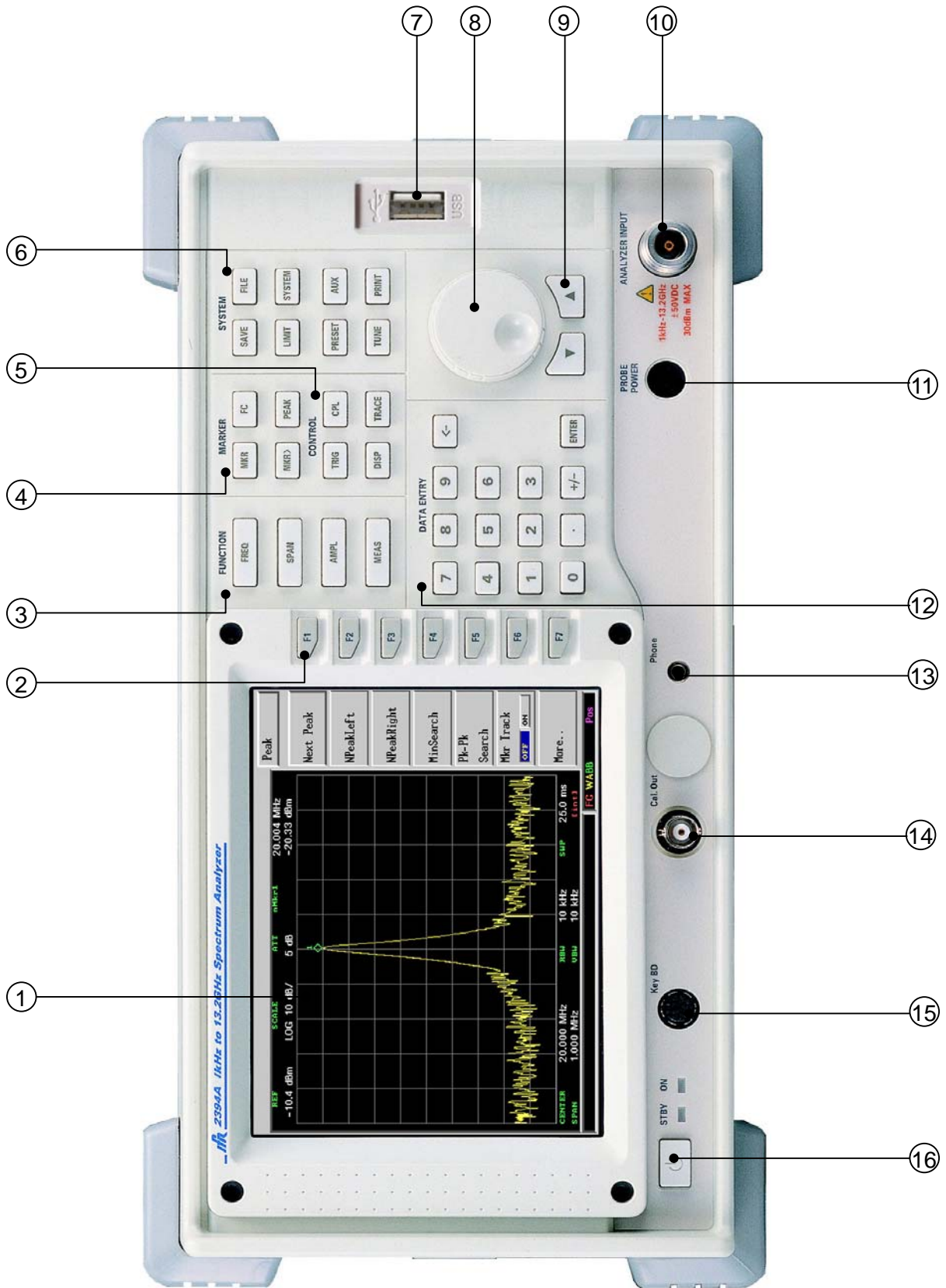

Fig 3-1. Front Panel

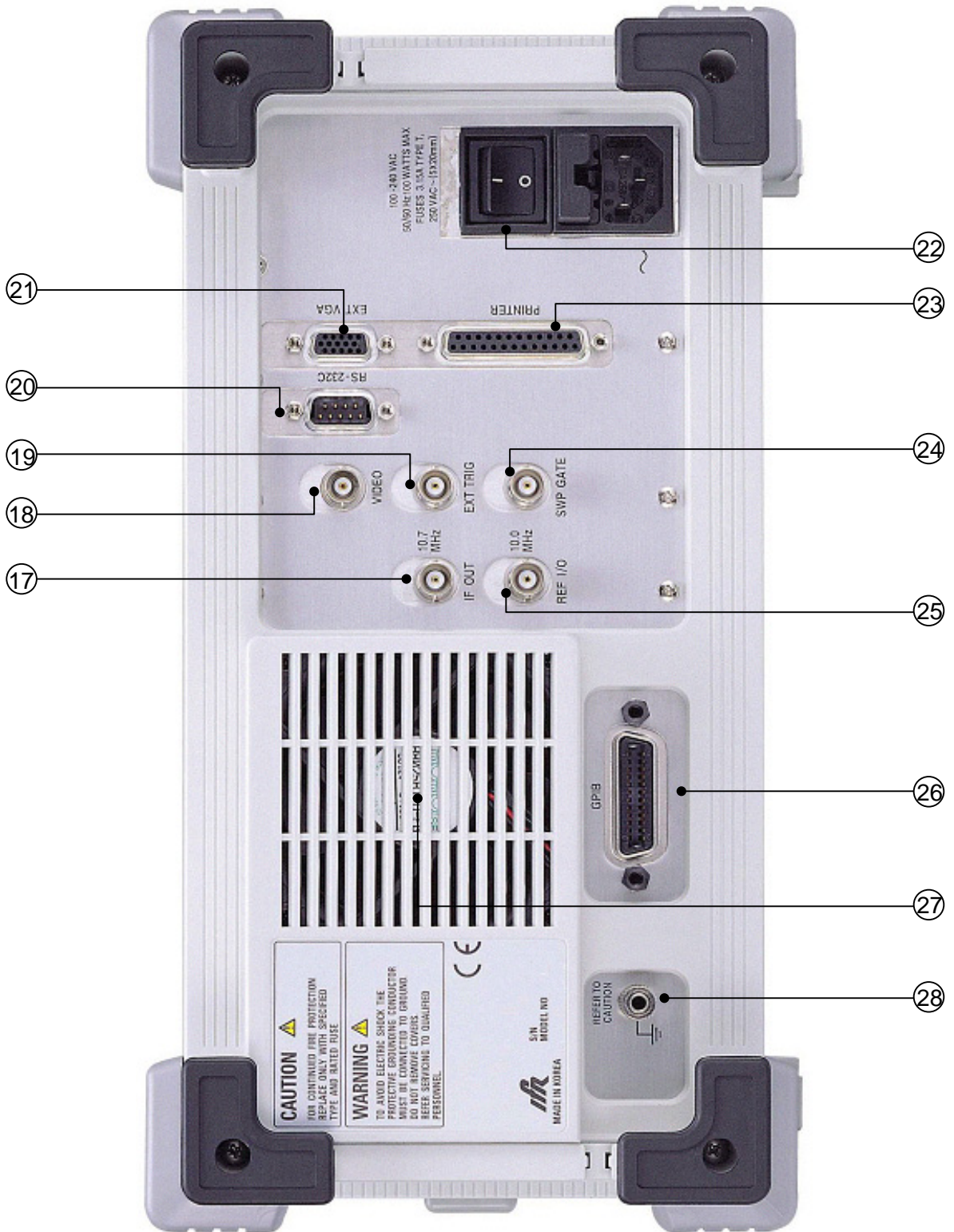

Fig 3-2. Rear Panel

TABLE OF I/O CONNECTORS

CONNECTOR	TYPE	IN/OUT	SIGNAL	LOCATION
AC INPUT	IEC 320 Socket	Input	AC Power	Rear (23)
RF INPUT	Type N Female or Type 2.92mm Female	Input	1 kHz ~ 13.2 GHz (2394A) 1 kHz ~ 26.5 GHz (2395A)	Front (10)
CAL. OUT	BNC Female	Output	20 MHz	Front (14)
EXT TRIG	BNC Female	Input	TTL LEVEL	Rear (20)
SWP GATE	BNC Female	Output	TTL LEVEL	Rear (25)
VIDEO	BNC Female	Output	0 ~ 5 VDC	Rear (19)
REF I/O	BNC Female	Input / Output	IN : 10 MHz OUT : 10 MHz	Rear (26)
IF OUT	BNC Female	Output	10.7 MHz	Rear (18)
GPIB	24-Pin Champ	IN/OUT	See Pin-Out (Table 2)	Rear (27)
PRINTER	25-Pin, D-sub Female	Output	Screen Print Data See Pin-Out (Table 4)	Rear (24)
RS-232C	9-Pin, D-sub Male	IN/OUT	See Pin-Out (Table 3)	Rear (21)
EXT VGA	15-Pin, D-sub Female	Output	See Pin-Out (Table 5)	Rear (22)

Table 1. I/O Connector

GPIB CONNECTOR

The IEEE-488 GPIB Connector complies with ANSI/IEEE Standard 488.2-1987.

PIN NUMBER	SIGNAL	PIN NUMBER	SIGNAL
1	DIO 1	13	DIO 5
2	DIO 2	14	DIO 6
3	DIO 3	15	DIO 7
4	DIO 4	16	DIO 8
5	EQI	17	REN
6	DAV	18	Ground
7	NRFD	19	Ground
8	NDAC	20	Ground
9	IFC	21	Ground
10	SRQ	22	Ground
11	ATN	23	Ground
12	Ground	24	Ground

Table 2. Pin-Out for IEEE-488 GPIB Connector

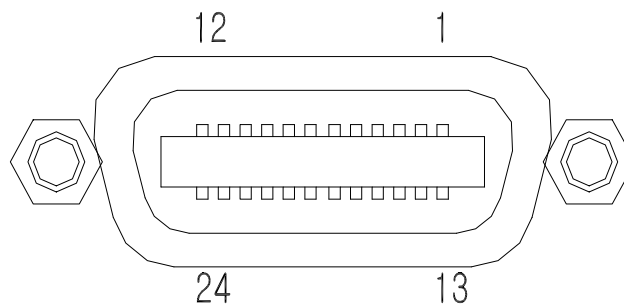

Figure 3. IEEE-488 GPIB Connector

RS-232C CONNECTOR

PIN NUMBER	SIGNAL
1	DCD
2	RXD
3	TXD
4	DTR
5	Ground
6	DSR
7	RTS
8	CTS
9	RI (NC)

Table 3. Pin-Out for RS-232C Connector

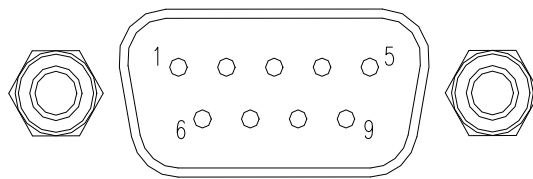

Figure 4. RS-232C Connector

PRINTER CONNECTOR

PIN NUMBER	SIGNAL
1	$\overline{\text{STB}}$
2	PD0
3	PD1
4	PD2
5	PD3
6	PD4
7	PD5
8	PD6
9	PD7
10	$\overline{\text{ACK}}$
11	BUSY
12	PE
13	SLCT
14	$\overline{\text{AFD}}$
15	$\overline{\text{ERROR}}$
16	$\overline{\text{INIT}}$
17	$\overline{\text{SLIN}}$
18	Ground
19	Ground
20	Ground
21	Ground
22	Ground
23	Ground
24	Ground
25	Ground

Table 4. Pin-Out for PRINTER Connector

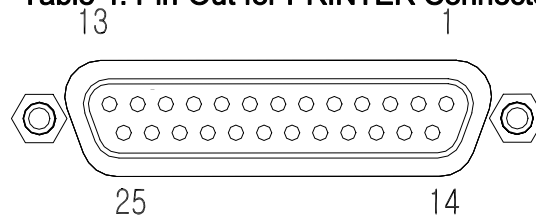

Figure 5. PRINTER Connector

EXT VGA CONNECTOR

PIN NUMBER	SIGNAL
1	RED
2	GREEN
3	BLUE
4	ID2
5	GND
6	RGND
7	GGND
8	BGND
9	KEY
10	SGND
11	ID0
12	ID1 or SDA
13	HSYNC or CSYNC
14	VSYNC
15	ID3 or SCL

Table 5. Pin-Out for EXT VGA Connector

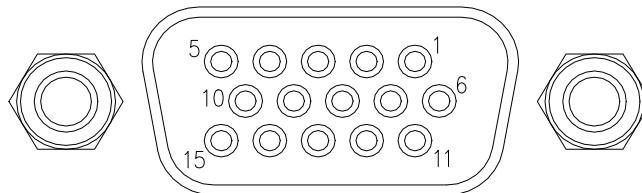

Figure 6. EXT VGA Connector

PROBE POWER CONNECTOR

PIN NUMBER	Voltage	Current
1	+15 V \pm 10 %	200 mA
2	-12 V \pm 10 %	100 mA
3	GND	

Table 6. Pin-Out for PROBE POWER Connector

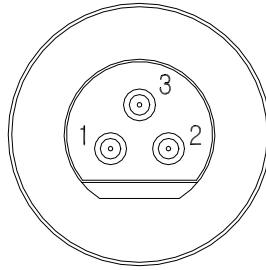

Figure 7. PROBE POWER Connector

SECTION 4 MENU TREE

TABLE OF CONTENTS

MENU TREE -----	4-4
FREQ, SPAN, AMPL -----	4-4
MEAS -----	4-5
MKR, FC -----	4-6
MKR > , PEAK -----	4-7
TRIG, CPL -----	4-8
DISP -----	4-9
TRACE -----	4-10
FILE -----	4-11
LIMIT, SYSTEM -----	4-12
PRESET, AUX -----	4-13

<BLANK>

SECTION 4 MENU TREE

In this section, soft menu functions and its system hierarchy are described using a menu tree. Contents to noted about the tree are shown below

- (1) Panel key indicates a hard key on the panel.
- (2) SOFT MENU 1 keys are displayed on the screen when the panel key is pressed. SOFT MENU 2 indicates another menu below the SOFT MENU 1.
- (3) When the *Prev.* key is pressed on SOFT MENU 2 keys.
It will go to SOFT MENU 1 menu.
- (4) The menu of disabled option or disabled function key will not operate with white letter on the function menu.

MENU TREE

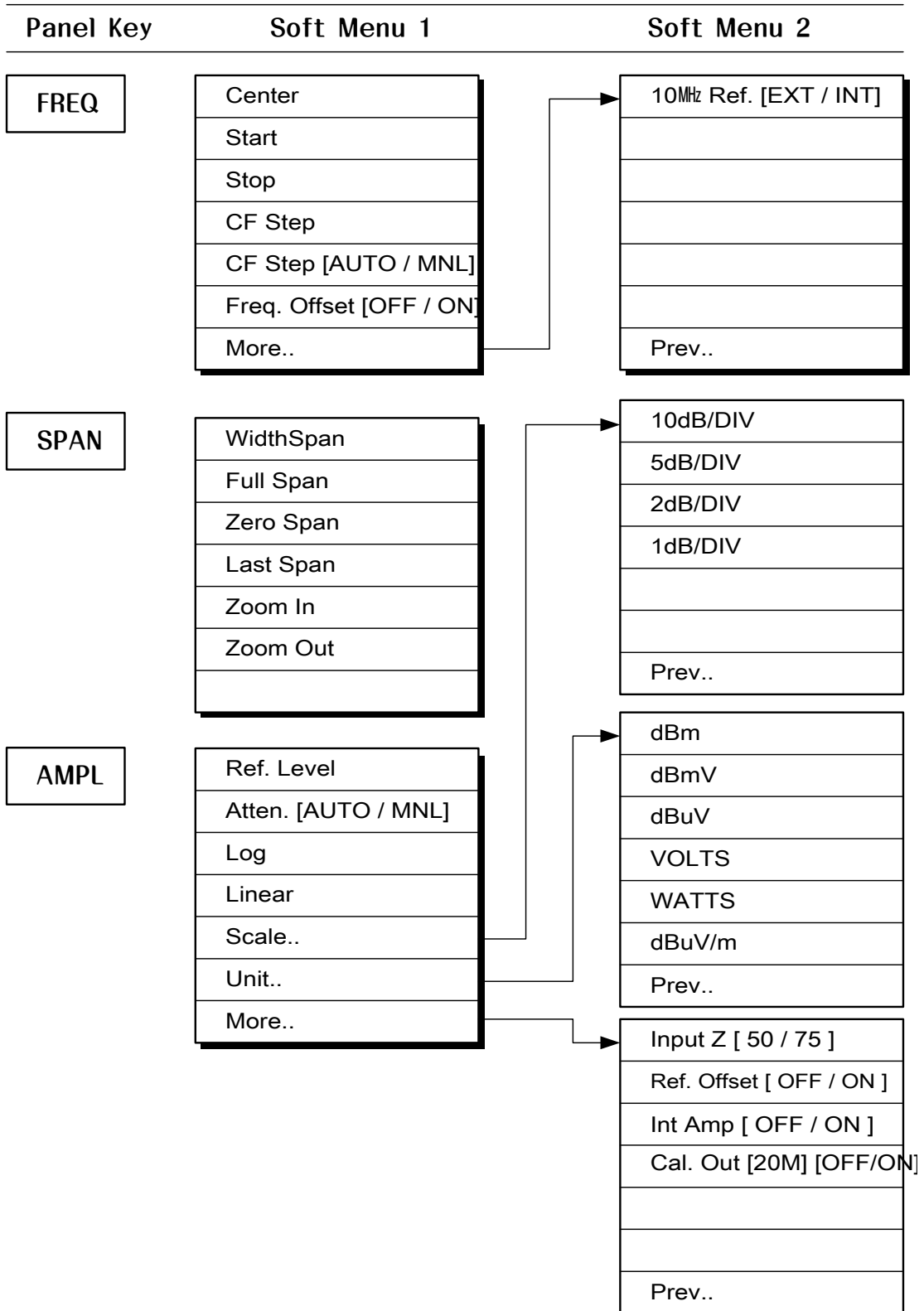

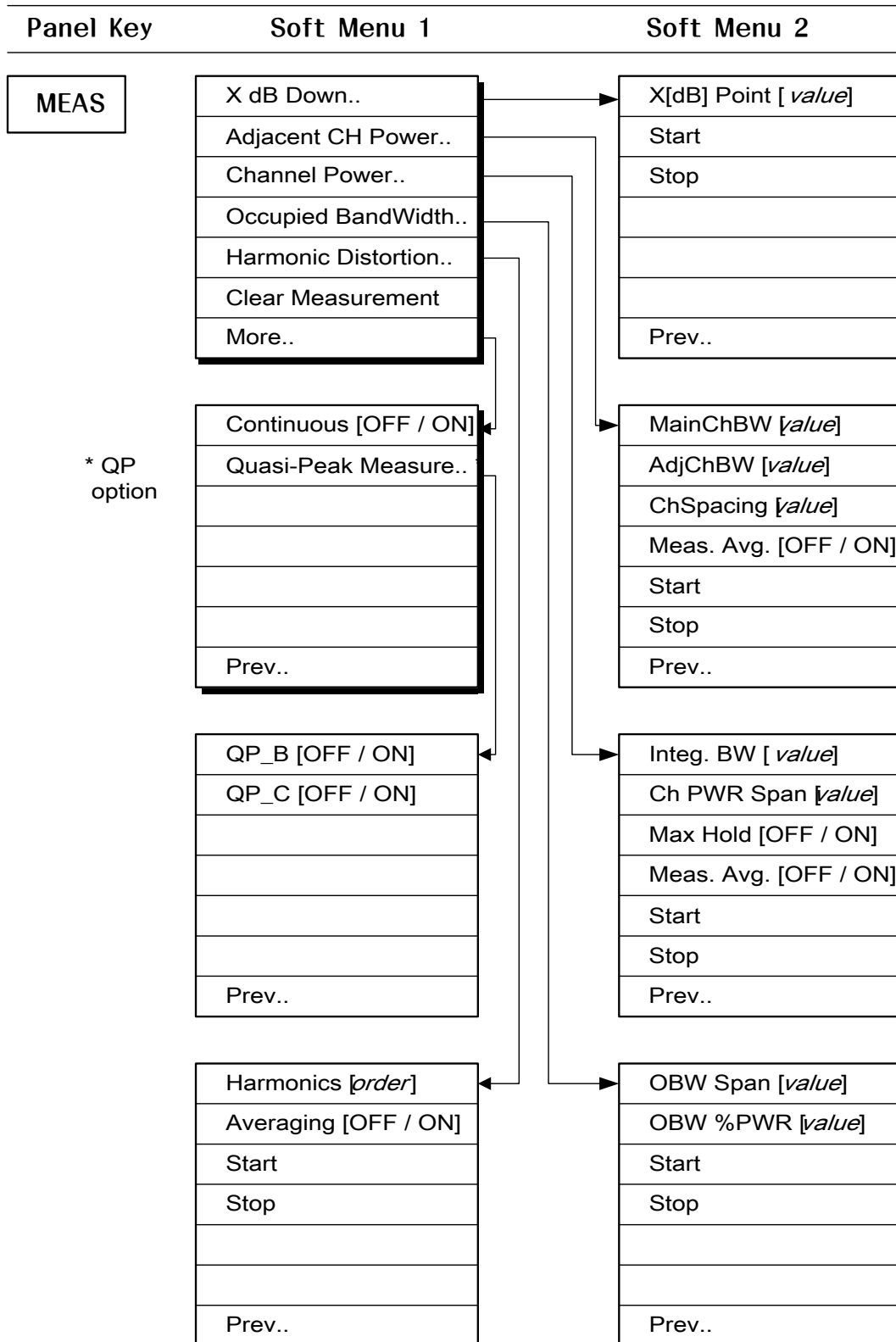

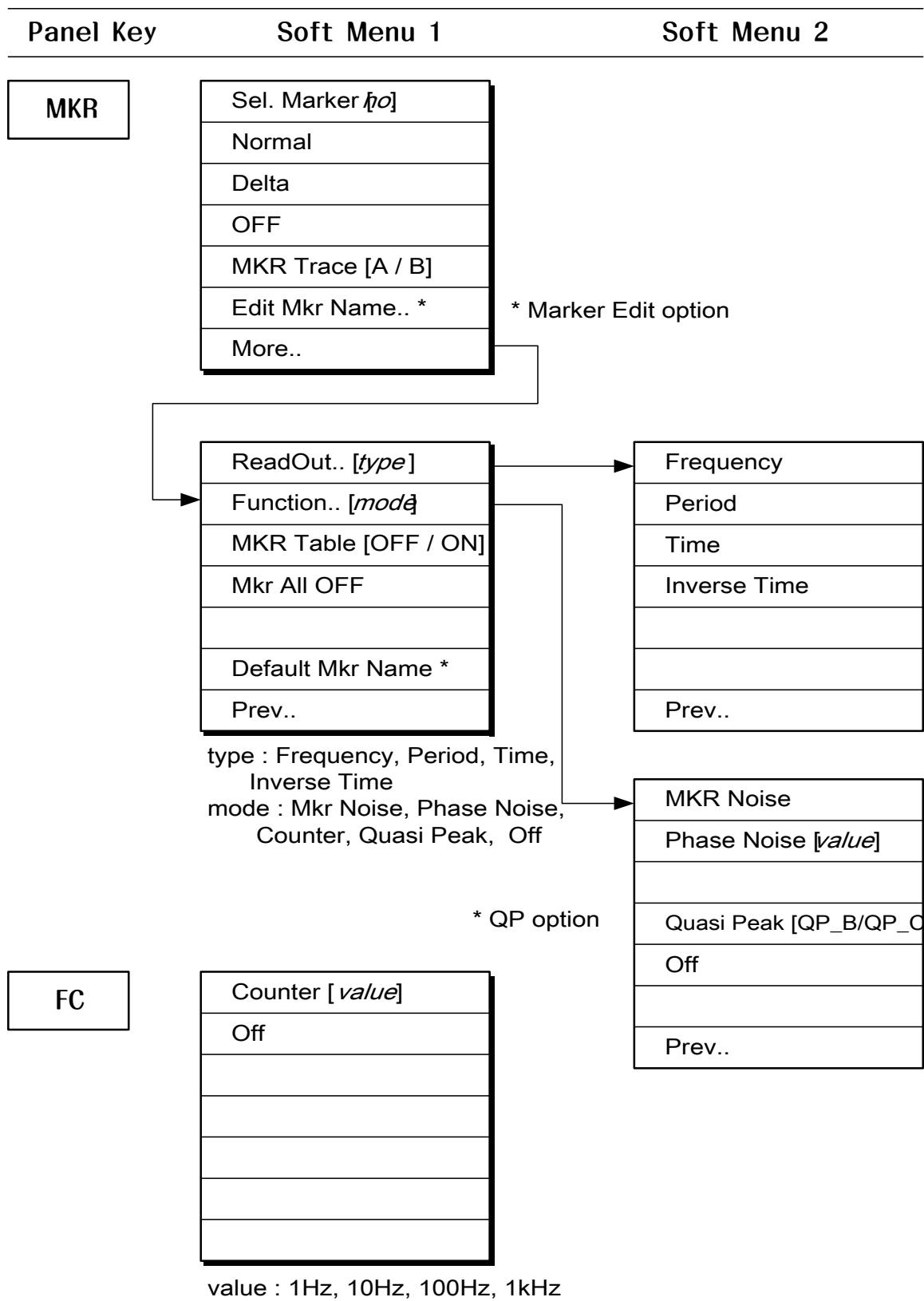

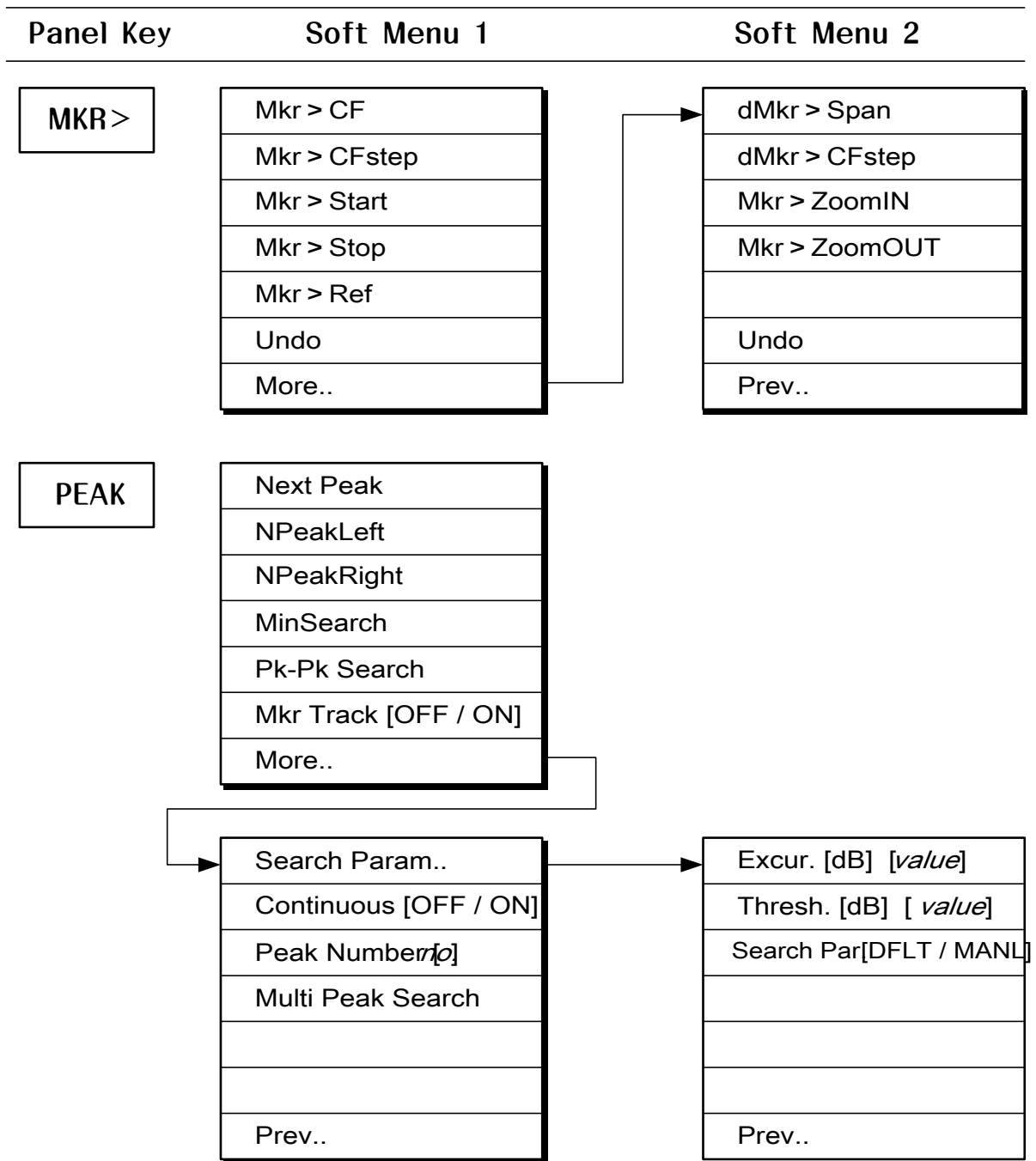

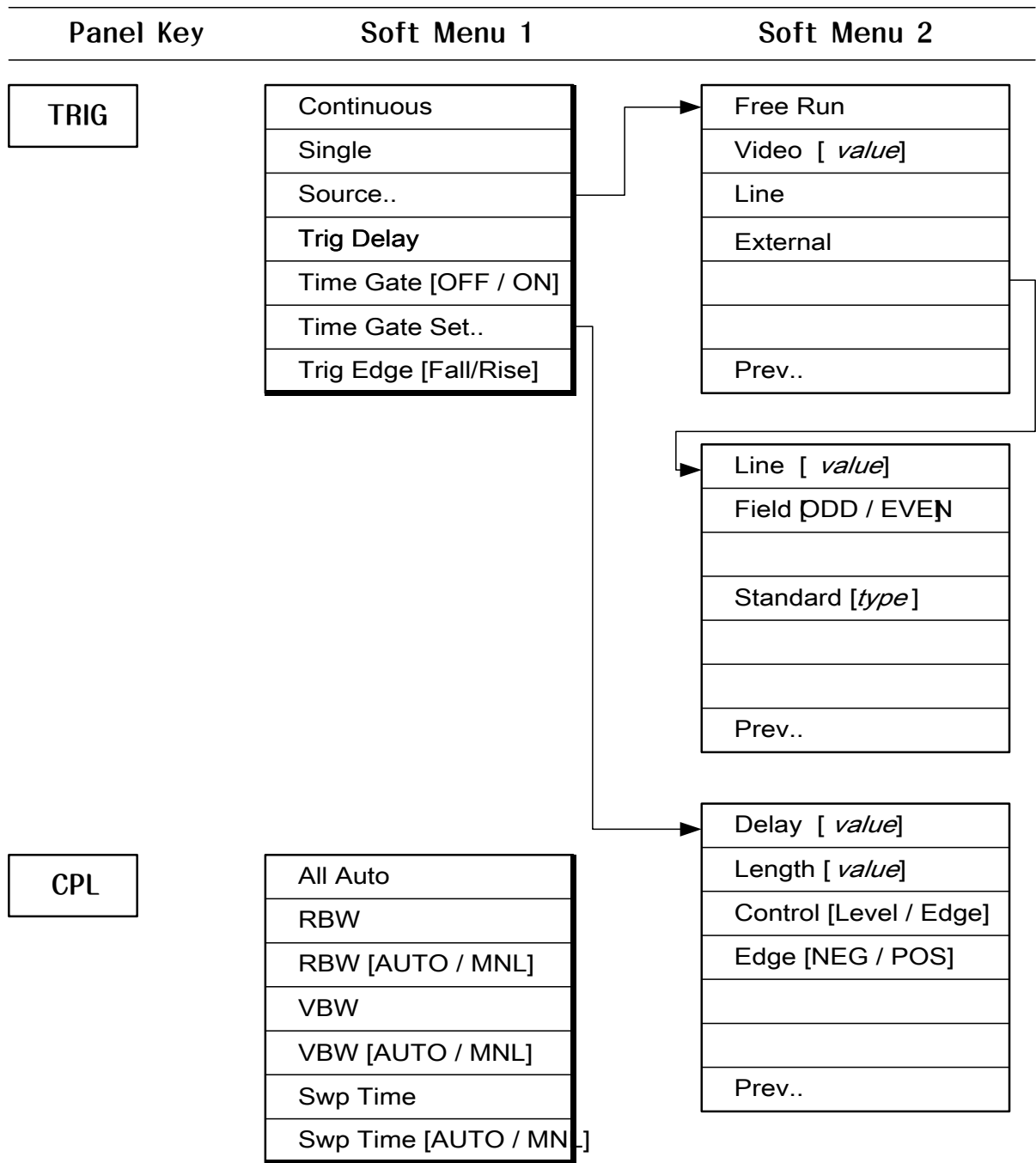

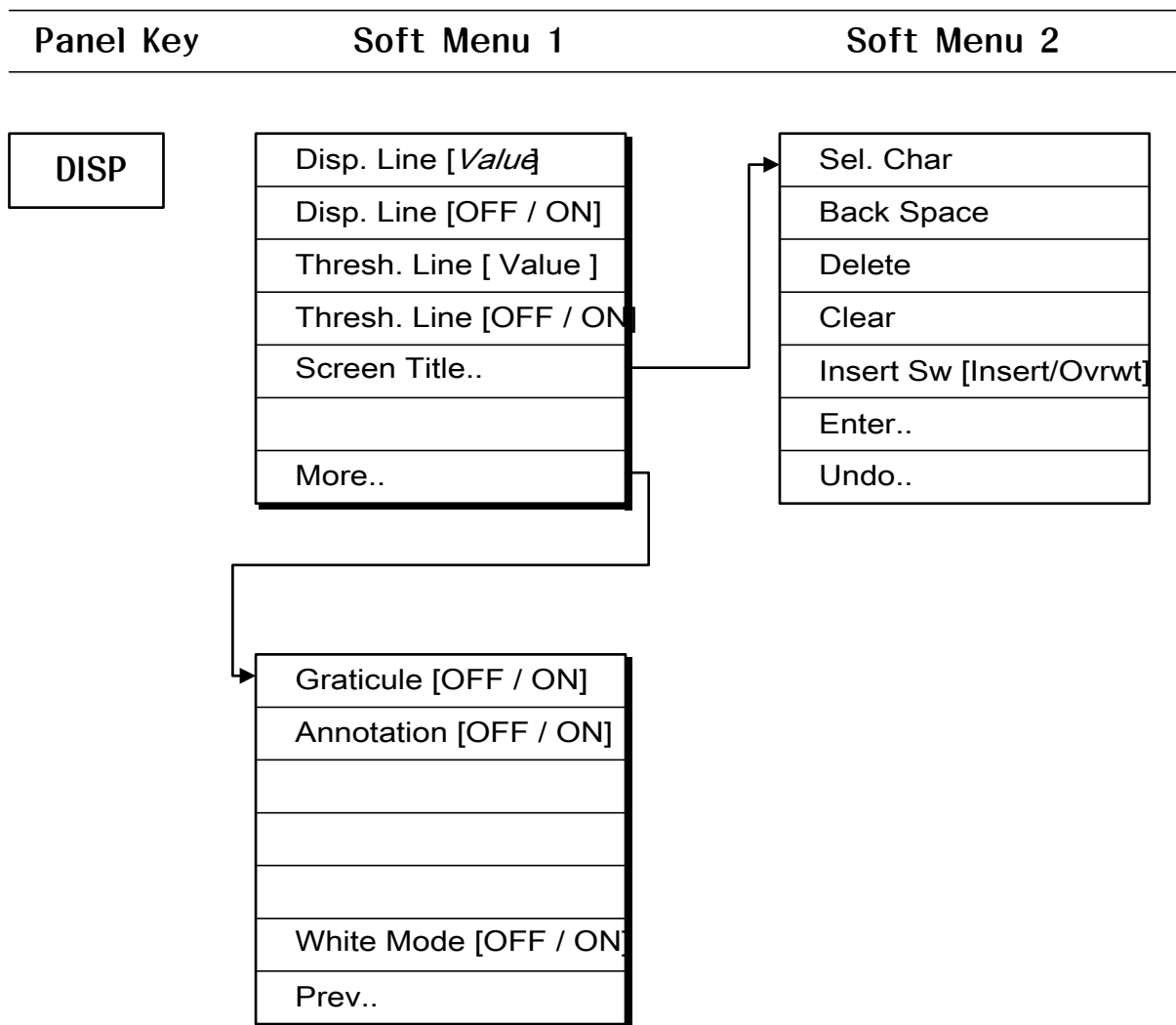

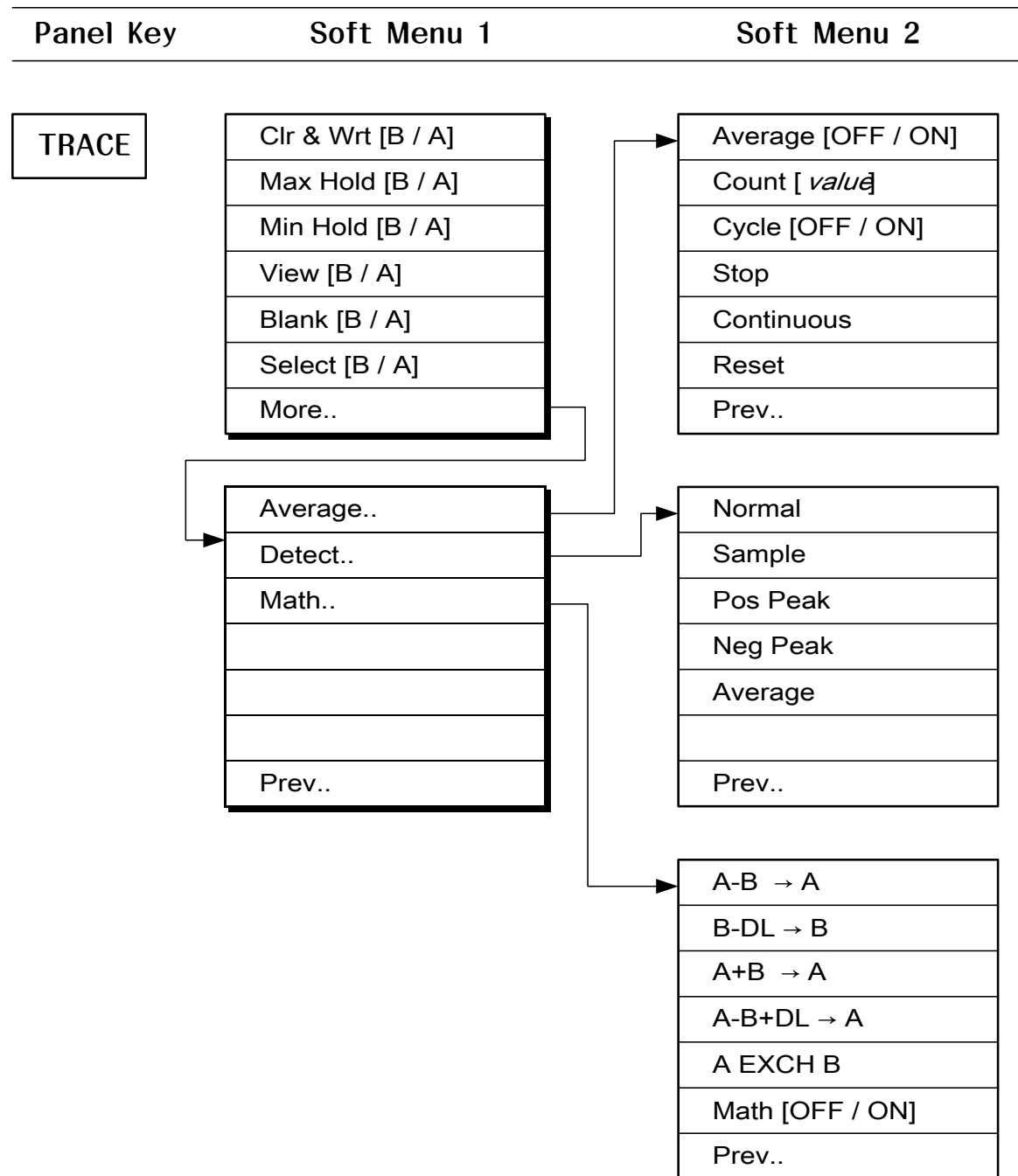

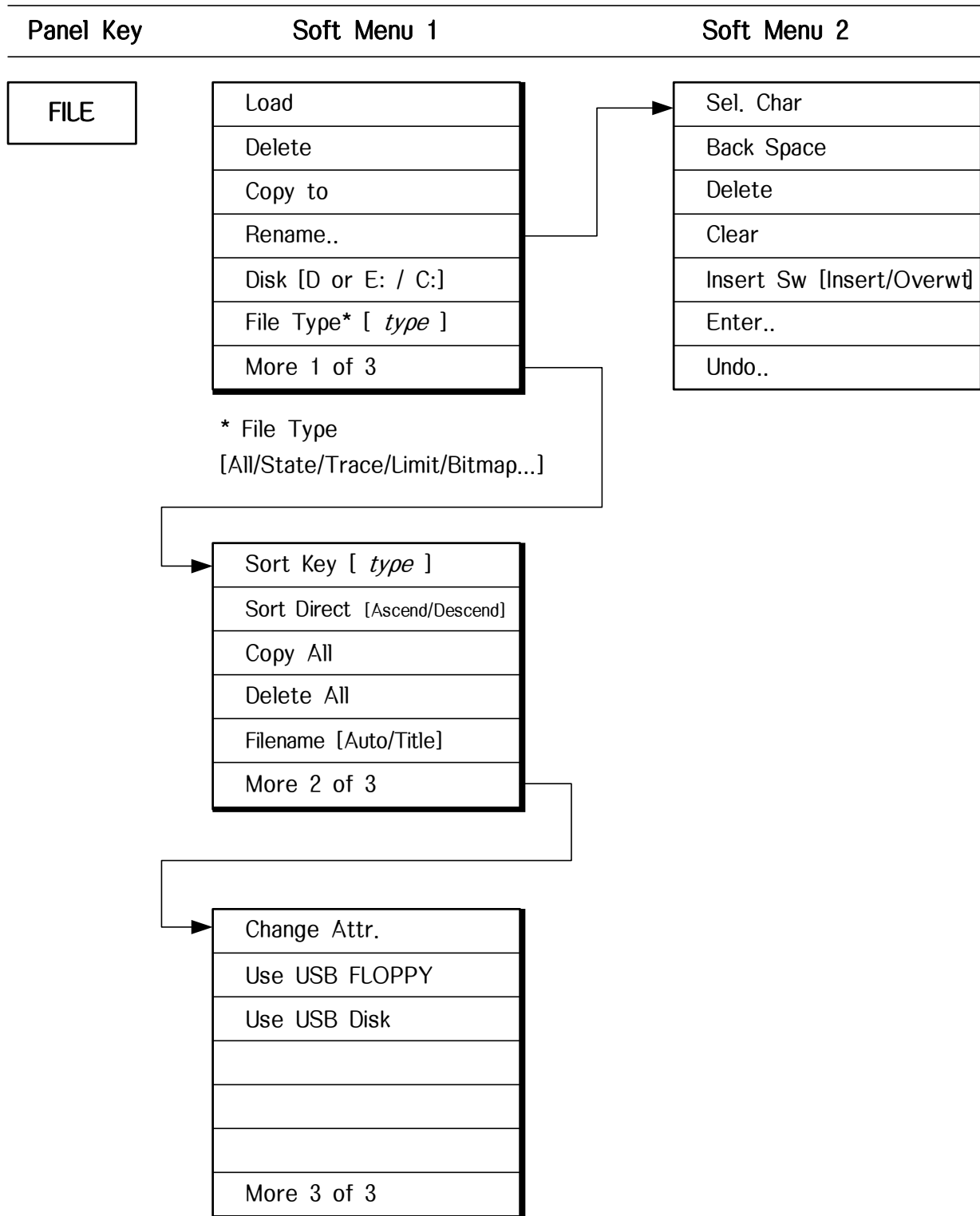

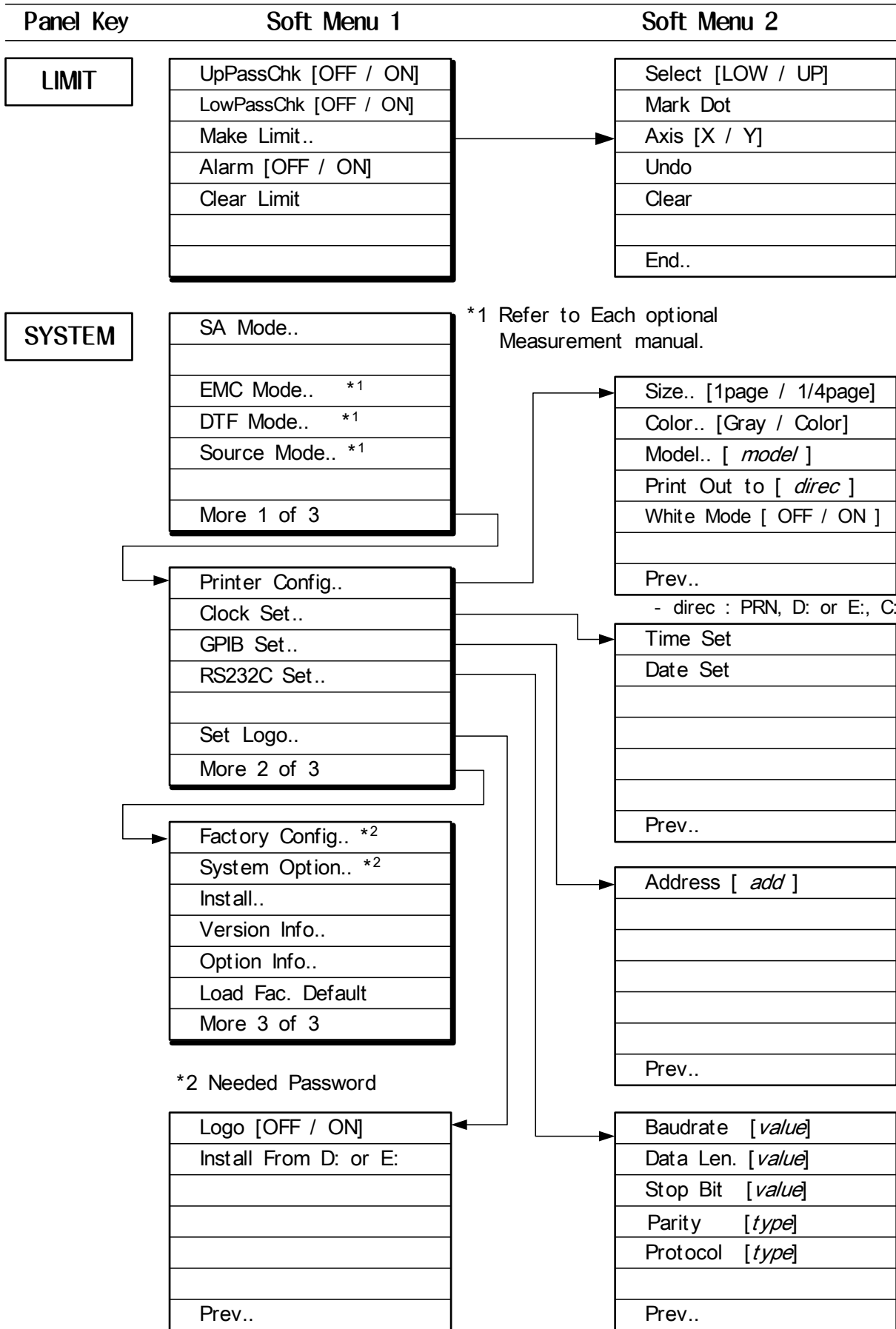

Panel Key	Soft Menu 1	Soft Menu 2															
PRESET	<table border="1"> <tr><td>Preset</td></tr> <tr><td>Last State</td></tr> <tr><td>Alignment Mode..</td></tr> <tr><td>Power On[Preset / Last]</td></tr> <tr><td>CalSig[20M]</td></tr> <tr><td>Auto Align [OFF / ON]</td></tr> <tr><td></td></tr> <tr><td></td></tr> </table>	Preset	Last State	Alignment Mode..	Power On[Preset / Last]	CalSig[20M]	Auto Align [OFF / ON]			<table border="1"> <tr><td>All Align</td></tr> <tr><td>Yig Align</td></tr> <tr><td>Span Align</td></tr> <tr><td>Level Align</td></tr> <tr><td></td></tr> <tr><td>RBW Align</td></tr> <tr><td>Prev..</td></tr> </table>	All Align	Yig Align	Span Align	Level Align		RBW Align	Prev..
Preset																	
Last State																	
Alignment Mode..																	
Power On[Preset / Last]																	
CalSig[20M]																	
Auto Align [OFF / ON]																	
All Align																	
Yig Align																	
Span Align																	
Level Align																	
RBW Align																	
Prev..																	
AUX	<table border="1"> <tr><td>AM Demod. [OFF / ON]</td></tr> <tr><td>FM Demod. [OFF / ON]</td></tr> <tr><td>Audio Sound [OFF / ON]</td></tr> <tr><td>Audio Level [value]</td></tr> <tr><td>Squelch Lev [value]</td></tr> <tr><td></td></tr> <tr><td></td></tr> </table>	AM Demod. [OFF / ON]	FM Demod. [OFF / ON]	Audio Sound [OFF / ON]	Audio Level [value]	Squelch Lev [value]											
AM Demod. [OFF / ON]																	
FM Demod. [OFF / ON]																	
Audio Sound [OFF / ON]																	
Audio Level [value]																	
Squelch Lev [value]																	

SECTION 5 OPERATING PROCEDURES

TABLE OF CONTENTS

SCREEN LAYOUT -----	5-5
ANNOTATION WINDOW -----	5-6
FREQ/SPAN FUNCTIONS -----	5-7
Center-Span Mode Frequency Data Entry -----	5-7
Start-Stop Mode Frequency Data Entry -----	5-8
Setting Center Frequency Step -----	5-9
Setting Frequency Offset -----	5-10
Setting Full Span -----	5-10
Setting Zero Span -----	5-11
Return to the Previous Span -----	5-11
Zoom In/Zoom Out -----	5-11
10 MHz Ref. -----	5-12
AMPLITUDE FUNCTIONS -----	5-13
Setting Reference Level -----	5-13
Selecting Log/Linear Detector Mode -----	5-13
Setting Amplitude Scale -----	5-14
Setting Amplitude Units -----	5-14
Setting Input Attenuation -----	5-15
Selecting Input Impedance -----	5-15
Setting the Reference Level Offset -----	5-16
Setting Internal Amp -----	5-16
Setting Calibration Signal Output -----	5-16
MEASUREMENT FUNCTIONS -----	5-17
X dB Down Measurement -----	5-17
Adjacent Channel Power Measurement -----	5-18
Channel Power Measurement -----	5-18
Occupied Bandwidth Measurement -----	5-19
Harmonic Distortion Measurement -----	5-20
Clear Measurement -----	5-21
Continue Measurement -----	5-21
Quasi-Peak (option) -----	5-21
MARKER FUNCTIONS -----	5-22
Selecting & Changing Marker Position -----	5-22
Normal Marker -----	5-23

Delta Marker -----	5-23
Marker Off by Reverse Step -----	5-24
Setting the MKR Trace -----	5-24
Setting the Marker Readout Mode -----	5-25
Setting the Marker Function -----	5-26
Setting the Marker Table -----	5-26
Off All Marker -----	5-27
Frequency Counter -----	5-27
SETTING PARAMETERS USING MARKER VALUES -----	5-28
MKR > CF / MKR > Ref -----	5-28
MKR > Start / MKR > Stop -----	5-28
Mkr > CFstep / dMkr > CFstep -----	5-29
dMkr > Span -----	5-29
Mkr > ZoomIN / Mkr > ZoomOUT -----	5-29
PEAK SEARCH FUNCTIONS -----	5-30
Peak Search -----	5-30
Next Peak Search -----	5-30
Peak Left Search/Peak Right Search -----	5-31
Marker Track -----	5-31
Peak to Peak Search -----	5-31
Setting the Search Parameters -----	5-32
TRIGGER FUNCTIONS -----	5-33
Continuous Sweep Mode -----	5-33
Single Sweep Mode -----	5-33
Trigger Source -----	5-34
Video Trigger -----	5-34
Line Trigger -----	5-35
External Trigger -----	5-35
Trigger Delay -----	5-35
Select Trigger Edge -----	5-36
Time Gate -----	5-36
Time Gate Menu -----	5-37
COUPLED FUNCTIONS -----	5-38
All Auto Function -----	5-38
Setting the Resolution Bandwidth(RBW) -----	5-39
Setting the Video Bandwidth(VBW) -----	5-40
Setting the Sweep Time -----	5-41
Input Attenuator -----	5-41
DISPLAY FUNCTIONS -----	5-43
Display Line -----	5-43

Threshold Line -----	5-44
Screen Title -----	5-44
Graticule -----	5-46
Annotation -----	5-46
White Mode -----	5-46
TRACE FUNCTIONS -----	5-47
Select Trace -----	5-47
Clr & Wrt -----	5-47
Max Hold -----	5-47
Min Hold -----	5-48
View -----	5-48
Blank -----	5-48
Averaging Function -----	5-49
Detection Mode -----	5-50
Mathematics Mode -----	5-51
SAVE AND FILE FUNCTIONS -----	5-52
Internal Memory -----	5-52
Save Parameters and Waveform -----	5-52
File Management -----	5-53
LIMIT LINE FUNCTIONS -----	5-56
SYSTEM CONFIGURATION -----	5-58
Printer Configuration -----	5-58
Clock Set -----	5-59
GPIB Address Set -----	5-59
RS-232C Configuration -----	5-60
System Information -----	5-61
PRESET FUNCTIONS -----	5-62
Preset -----	5-62
Last State -----	5-63
Alignment Mode -----	5-63
Power ON -----	5-64
Auto Align -----	5-64
AUX FUNCTIONS -----	5-65
AM Demodulation -----	5-65
FM Demodulation -----	5-65
Audio Monitor -----	5-66
Auto Tune -----	5-67

SECTION 5 OPERATING PROCEDURES

SCREEN LAYOUT

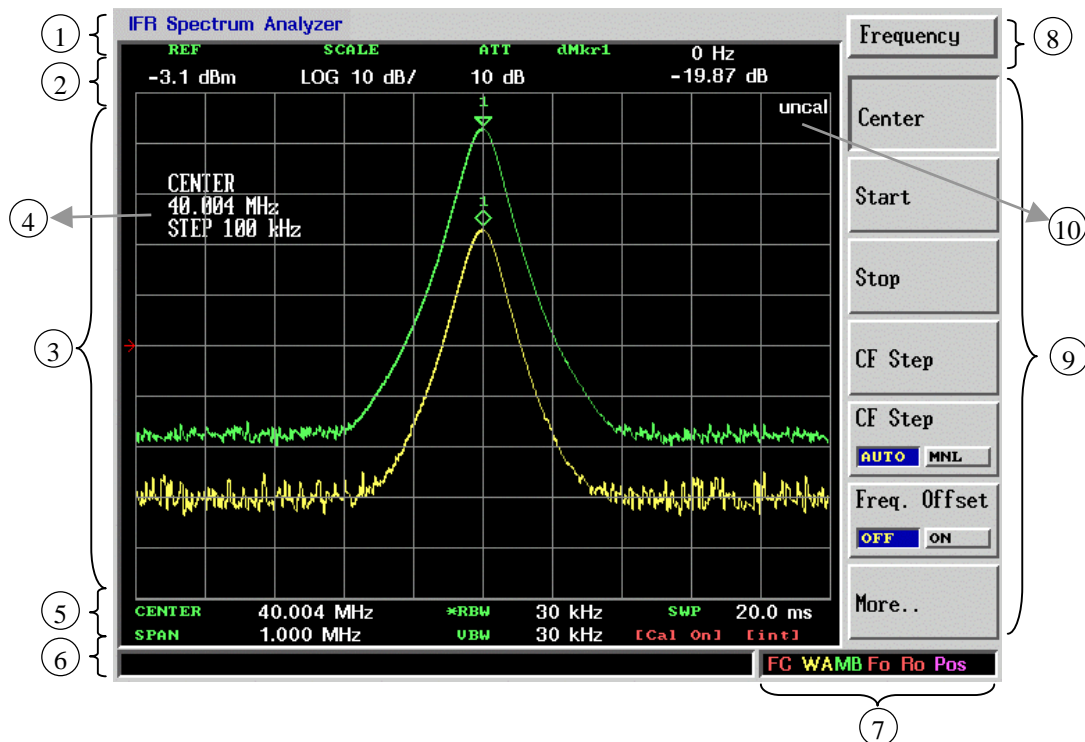

- ① Title window : Display Model, Date, Time, User title.
- ② Upper parameter : Display Reference level, Scale, Attenuator, Mark parameter.
- ③ Wave display window : Display current trace A or B wave form.
- ④ Active window : Display current active menu parameter.
- ⑤ Lower parameter : Display Freq. Info., RBW, VBW, Sweep time, Cal signal on/off, 10 MHz Ref info.
- ⑥ Status window : Display current job processing status.
- ⑦ Annotation window : Display Trig, Trace, Freq. offset, Level offset, Detect mode. (ref : Annotation Window 5-6)
- ⑧ Hard key menu : Display Selected hard key.
- ⑨ Soft key menu : Display Available soft function of selected hard key.
- ⑩ Uncal, average : Display the status of signal validity or average number.

ANNOTATION WINDOW

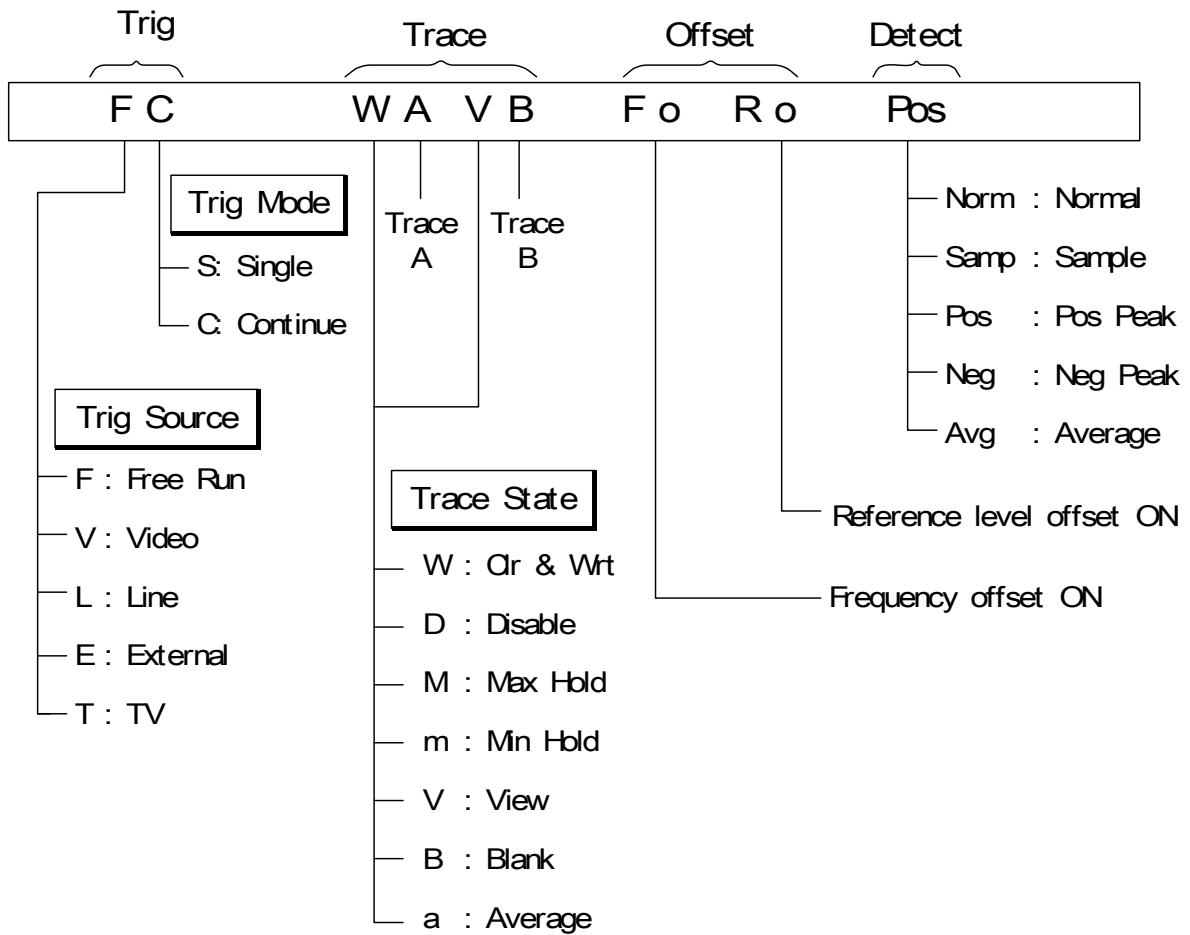

FREQ/SPAN FUNCTIONS

A frequency of the equipment is set in either of two modes.

- Center – Span Mode.
- Start – Stop Mode.

The lower and upper span limits are 1kHz and 13.2GHz (2394A) / 26.5GHz (2395A), respectively.

The **FREQ** key is used as the header key for setting the frequency.

The **SPAN** key is used as the header key for setting the frequency span.

Center – Span Mode Frequency Data Entry

1) Setting the center frequency

To set the center frequency, perform the following key operations :

(Numeric key, step key, and scroll knob are said DATA ENTRAY)

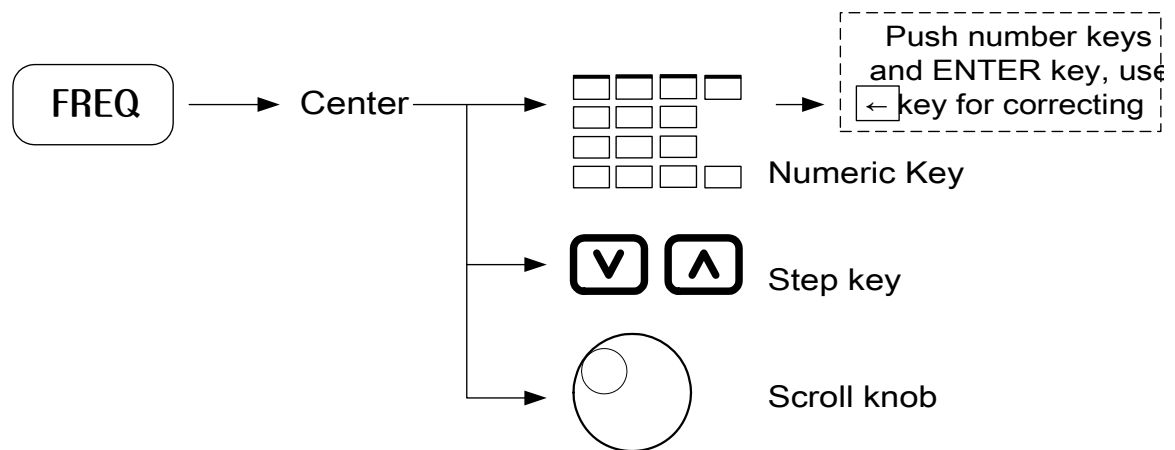

The step size of step up-down key is 1/10 of current frequency span. (CF Step was set in MNL)

The step size of scroll knob is 1/500 of the current frequency span.

Span can be changed if center move to near the boundary.

Example : Center 40 MHz , Span 80 MHz, and change the center to 20 MHz then span will be 40 MHz.

2) Setting the frequency span

To set the frequency span, perform the following key operations :

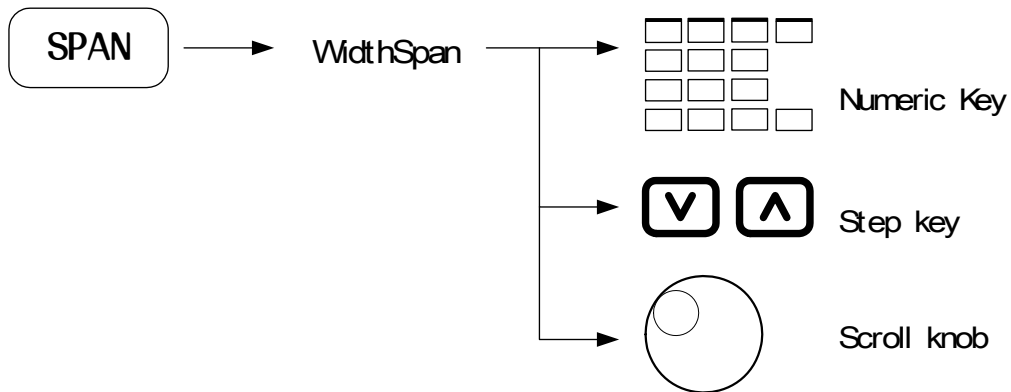

Span range is 100 Hz ~ 13.2GHz (2394A) / 26.5GHz (2395A).

Changes in a 1, 2, 5 step sequence ; 1k, 2k, 5k,, 100k, 200k, 500k, ...

The step size of scroll knob is 1/500 of the current frequency span.

Start – Stop Mode Frequency Data Entry

1) Setting the start frequency

To set the start frequency, perform the following key operations :

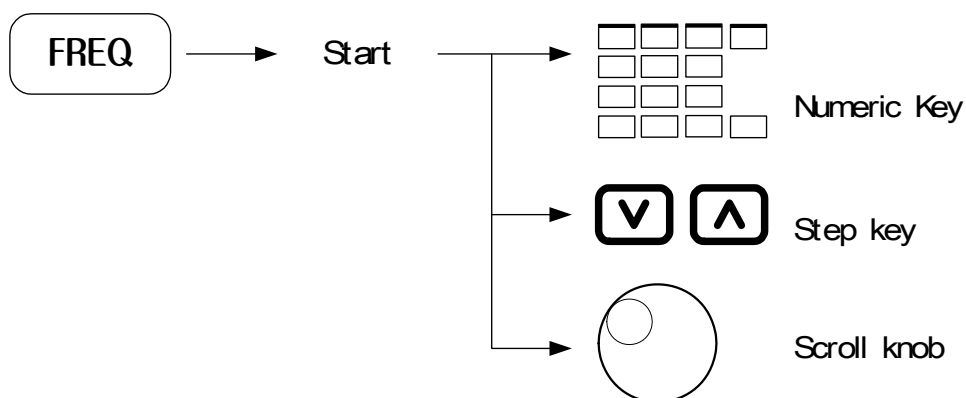

The step size of step up-down key is 1/10 of current frequency span.

The step size of scroll knob is 1/500 of the current frequency span.

2) Setting the stop frequency

To set the stop frequency, perform the following key operations :

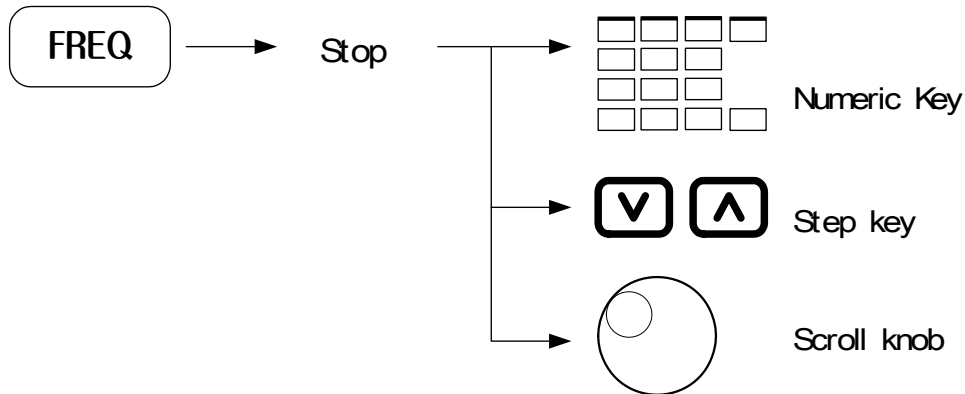

The step size of step up-down key size is 1/10 of the current frequency span.

The step size of scroll knob is 1/500 of the current frequency span.

Note : The start and the stop frequency are also determined by setting the center and the span frequency. For example, if the center frequency is 40 MHz and the span frequency is 20 MHz, the start and the stop frequency are determined as 30 MHz and 50 MHz respectively.

Setting Center Frequency Step

To identify the step size as following :

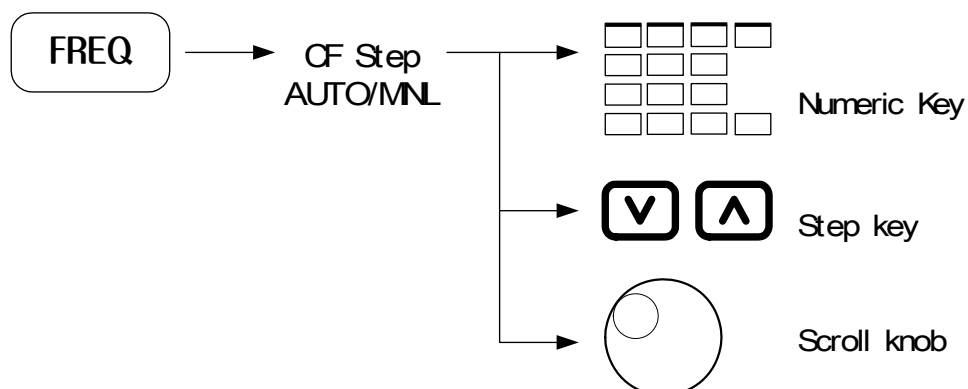

The CF Step mode is changed from AUTO to MNL mode by pressing *CF Step* soft key.

In CF Step MNL (manual) mode, the step size can be set by the DATA ENTRY.

If CF Step [AUTO/MNL] “AUTO” is selected, the CF Step size will be 1/10 of the current span.

Setting Frequency Offset

To set frequency offset, perform the following key operations :



The Freq. Offset mode is changed from OFF to ON mode by pressing *Freq. Offset* soft key.

In Freq. Offset [ON] mode, the frequency-offset size can be set by the numeric key.

The settable frequency offset is up to ± 999 GHz.

Setting Full Span

To set full span and leave the other parameters, perform the following key operations :

Set to start frequency is 0 Hz and stop frequency is 13.2GHz (2394A) / 26.5GHz (2395A).



Setting Zero Span

This equipment can operate as a selective level meter in which the horizontal axis is changed as a time axis by setting the frequency span to 0 Hz.

The rising and falling edges of signal burst wave can also be observed and measured.

Performing any of the following key operations allows the equipment to operate in the zero span mode.

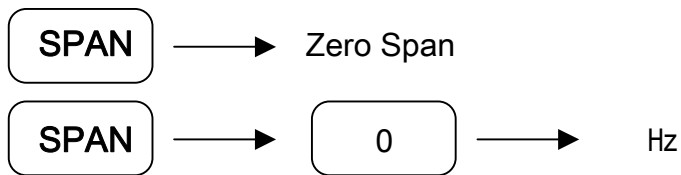

Return to the Previous Span

The previous span is returned by the following key operation.



Zoom In/Zoom Out

The Zoom In function changes the span from the current span to 1/2 of the current span.

The Zoom Out function changes the span from the current span to 2 times the current span.

The center frequency is not changed.

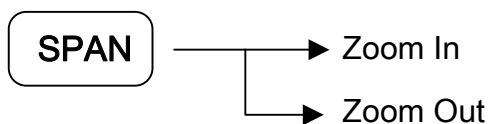

10 MHz Ref.

Set the reference clock for this equipment.

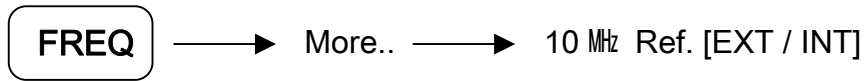

Default setting is INT.

AMPLITUDE FUNCTIONS

The **AMPL** key is used the header key for setting the amplitude.

Setting Reference Level

Set the reference level (top graticule) by performing the following key operations :

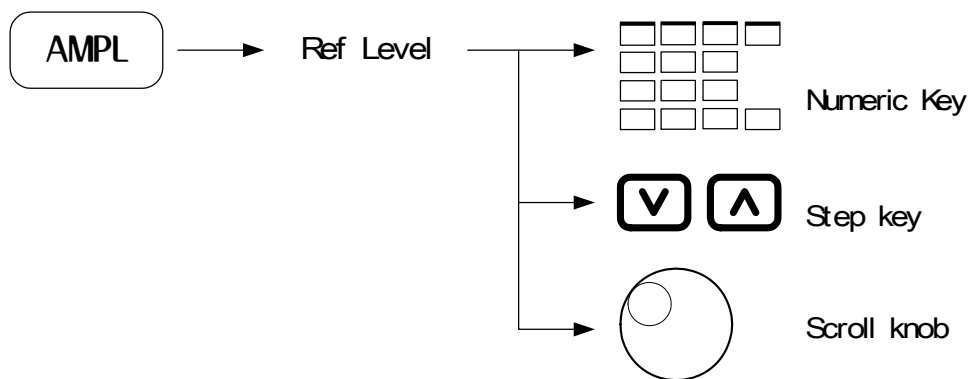

The step key size is the 1 division of current scale. (ref : Setting Amplitude Scale 5-14)

The scroll knob step size is 0.1 dB.

Selecting Log/Linear Detector Mode

To set the amplitude scale to log scale or linear scale, perform the following key operations :

(1) Setting log detector

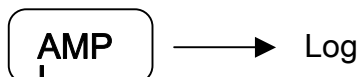

(2) Setting linear detector

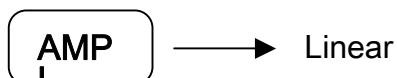

The reference level remains constant, independent of switching between log and linear.

Setting Amplitude Scale

In log scale, this equipment provides the four scales : 10dB/DIV, 5dB/DIV, 2dB/DIV, 1dB/DIV.

In linear scale, the equipment uses the Full Scale.

To select one of the scales, perform the following key operations :

- Log Detector Mode

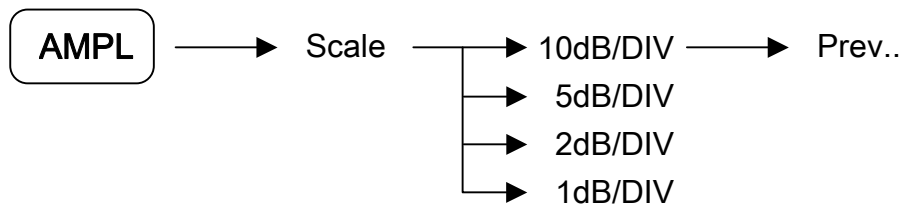

Setting Amplitude Units

In log scale, this equipment provides the five types of reference level units : dBm, dBmV, dBuV, VOLTS, WATTS.

To select on of the reference level units, perform the following key operations.

The reference level unit used for the linear scale is only in Volt.

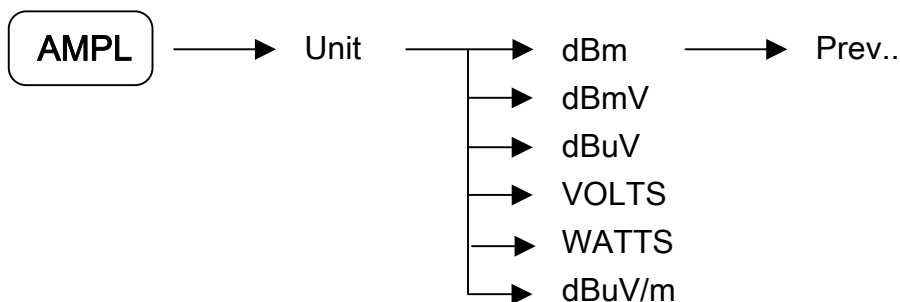

Setting Input Attenuation

Perform the following key operation to set the input attenuator level.

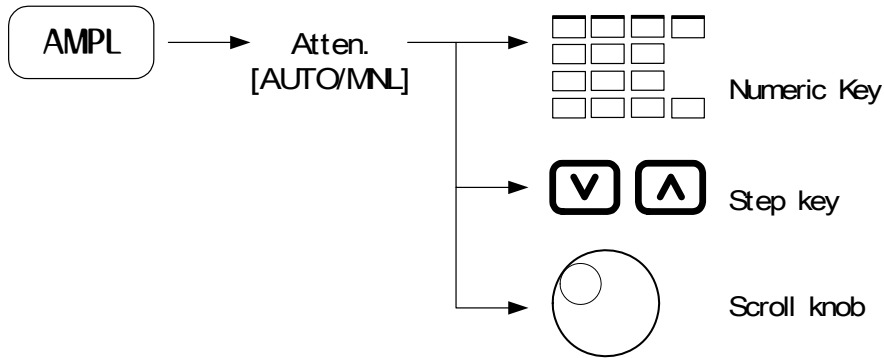

The Atten. mode [AUTO or MNL] is changed by pressing the Atten key.

In Atten MNL (manual) mode, the step size can set by the numeric keys, step keys and scroll knob. (Range 0 to 55 dB) (refer Input Attenuator at 5-40 page)

If Atten “AUTO” is selected, the input attenuator will be coupled by the current reference level automatically.

Selecting Input Impedance

To select on of the input impedance, perform the following key operations.

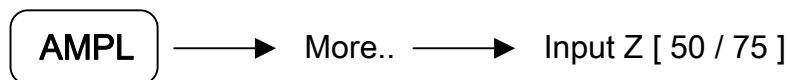

Using *Input Z* [50 / 75] menu, selecting input impedance 50 ohm or 75 ohm. When Input Z [75] is selected, this gives the method that user can use this equipment in such environment as ignore reflection and calculate considering purely impedance matching.

Setting the Reference Level Offset

Set the reference level offset by performing the following key operations :



The reference level offset size is -217.6 dB to 297.6 dB.

Setting Internal Amp

Set the internal amp to operate by performing the following key operations :

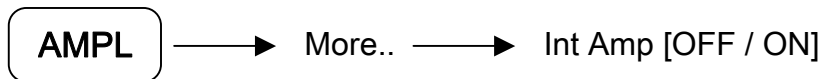

This function can use up to max 3GHz(2.95GHz)

CAUTION



Operate only in lower -20 dBm input signal level. Otherwise this equipment will damage.

Setting Calibration Signal Output

To set the calibration signal(20 MHz, -20dBm), perform the following key operations :

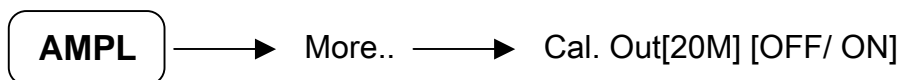

MEASUREMENT FUNCTIONS

The equipment provides the following measurement functions :

- X dB Down Measurement
- Adjacent Channel Power Measurement
- Channel Power Measurement
- Occupied Bandwidth Measurement
- Harmonic Distortion Measurement

The measurement can be made in single or continuous sweep mode. Using Continuous [OFF/ON] Softkey. Each measurement should close by press **MEAS** *Clear Measurement*.

X dB Down Measurement

The X dB Down function displays the difference in frequency between a reference marker (\diamond) and another marker ($\rightarrow \leftarrow$) that is X dB down from the reference.

The relative dB range that can be specified for X from the screen dynamic range is selected using the step key or scroll knob. The default value is 3 dB.

To use the X dB Down measurement function, perform the following key operations :

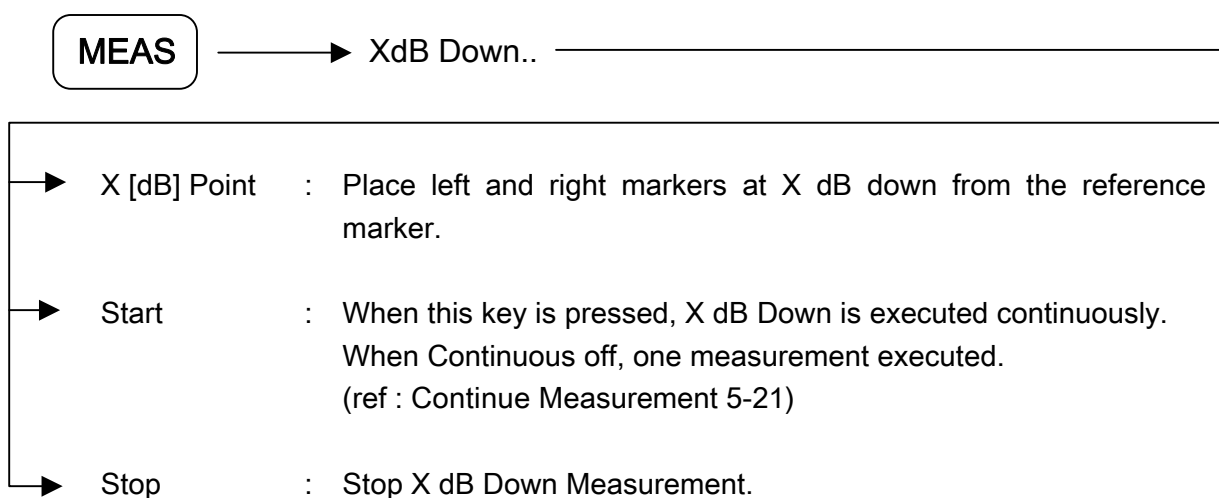

Adjacent Channel Power Measurement

Determine the power in the center and adjacent channels of a signal (designated by three of marker line).

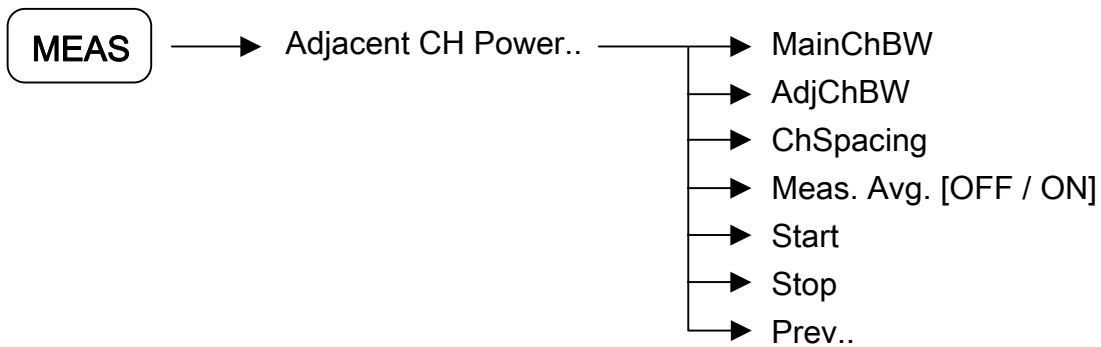

The measurement setup is done by numeric keys, step keys or scroll knob after pressed each soft key. [*MainChBW*, *AdjChBW*, *ChSpacing*] These BW and spacing will be adjusted until warning or error message on the bottom of measurement clear. To get more stable measurement value, *Meas Avg.* function can be set ON.

Channel Power Measurement

Measure the power and power spectral density in the channel bandwidth specified by user.

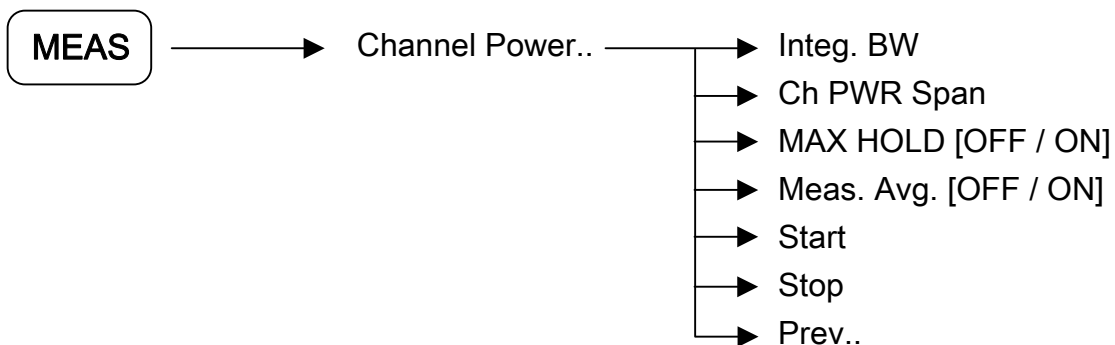

The measurement setup is done by numeric keys, step keys or Scroll knob after each soft keys [*Integ BW*, *Ch PWR Span*]. These BW and spacing will be adjusted until warning or error message on the bottom of measurement clear. To get more stable measurement value, *Meas Avg.* function can be set ON.

The center frequency, reference level and channel bandwidth must be set by user.

Occupied Bandwidth Measurement

Locate the occupied bandwidth of the signal being displayed on the screen.

The results are shown in the marker display area for the occupied bandwidth (OBW), the occupied band carrier frequency (Fc), and the band center frequency.

The equipment has an OBW function that can be calculated from the measurement data displayed on the screen. It works by finding the frequency band that contains a specified percentage of the total power. The default value is 98%, and measurement range between 5% and 100% can be specified.

OBW Measurement Procedure

- (1) Set the center frequency & normal marker to the known carrier frequency and set the frequency, span, resolution bandwidth (RBW), and sweep time to AUTO.
- (2) Calculate the Occupied Bandwidth by performing the following key operations :

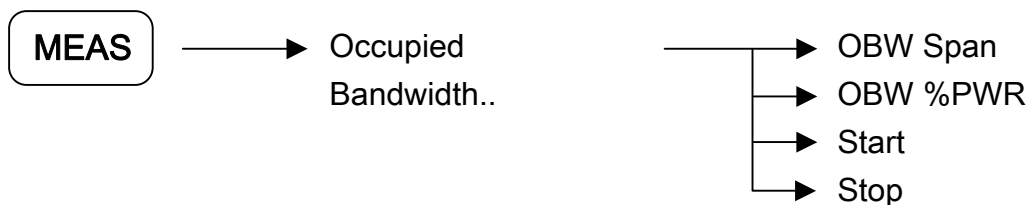

- (3) To change the ratio between the power contained in the occupied and the total power first find the OBW, then use the numeric keys to set a new percentage. The band markers will be adjusted automatically.

OBW Span is the same Span.

Harmonic Distortion Measurement

Measure the harmonics of a single carrier signal and compute the total harmonic distortion. The carrier must be the strongest peak on the display at the time the measurement is started. The total harmonic distortion is then calculated from the measured harmonics.

When measuring the Nth Harmonic the analyzer will choose the narrowest resolution bandwidth allow the measurement to capture all modulation on the harmonics.

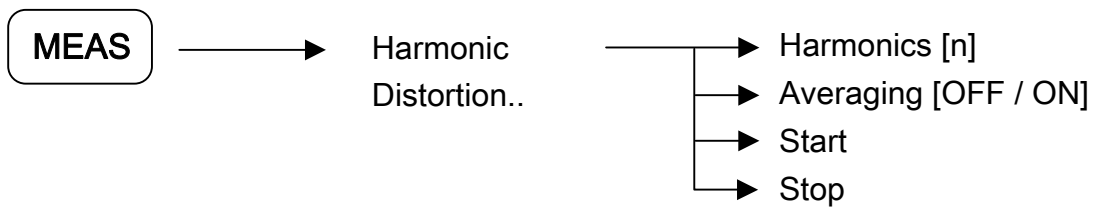

Harmonics value is 2 ~ 5 and default is 2. Averaging on for easily peak finding in each harmonics.

Recommend SPAN value is less than 8 MHz for accuracy measurement.

Clear Measurement

Stop the current measurement and close measurement.

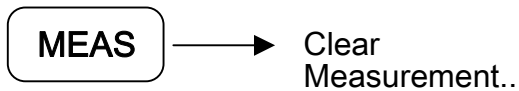

Continue Measurement

Select the measurement mode between continuous and else. Default mode is continuous on. When continuous off, current measurement operate just one by press start menu in each measurement.

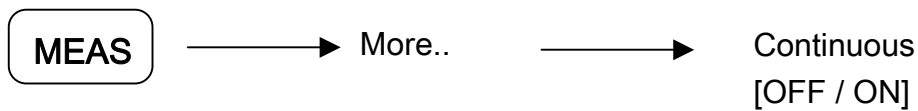

Quasi-Peak (option)

Measure the quasi peak in B band and C/D band.

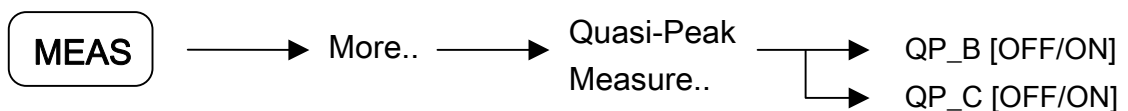

MARKER FUNCTIONS

The inner key section is used as the header key for setting the marker functions.

The **MKR** key is used as the header key to display markers.

The number of settable marker is up to 9.

Selecting & Changing Marker Position

Press **MKR** key, activated Marker 1 as default. Single Marker is indicated by \diamond on the waveform.

Use the step up down key to move the active maker position in 1division steps.

When the up step key is pressed, the marker position is moved to the right direction.

The down step key direction is left.

The scroll knob step size is 1/500 of the horizontal line also be used Numeric key.

1) Selecting Marker

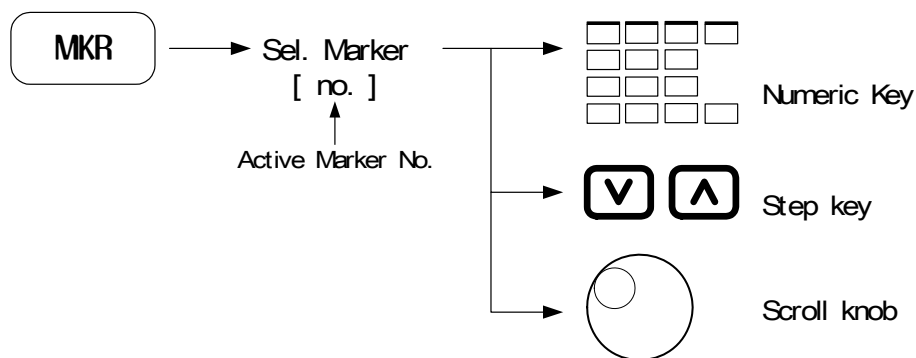

2) Moving Marker

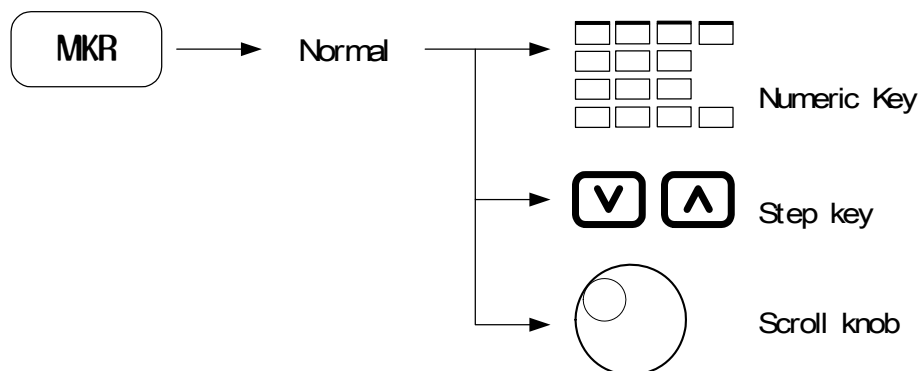

Normal Marker

A single marker is indicated by \diamond on the waveform. The frequency and level at that point are displayed digitally.

The normal marker is initially set to ON. When the current state is another marker mode, or when the normal marker is set to OFF, perform the following key operations to set the normal marker ON.

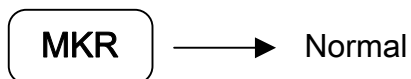

The normal marker displays the absolute amplitude level.

Delta Marker

To current marker position, when the delta marker is set to ON, is fixed as the reference marker (reference point). Then, as the current marker is moved, the reference marker and the current marker frequency (time) and level differences are displayed digitally as delta marker values.

In the delta marker mode, the reference marker is indicated by ∇ .

To set the delta marker to ON, perform the following key operation :

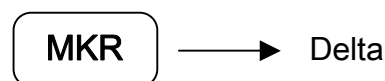

Press the *Delta* key in the delta marker mode. The reference marker moves to the current marker position and switches to the delta marker mode with that as the reference point.

Marker Off by Reverse Step

The markers are turned off from the screen by the following key operation :

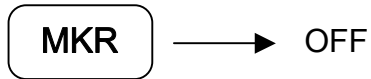

The markers are disappeared by reverse step by pressing soft menu “OFF”
If you want turn off the specific marker,

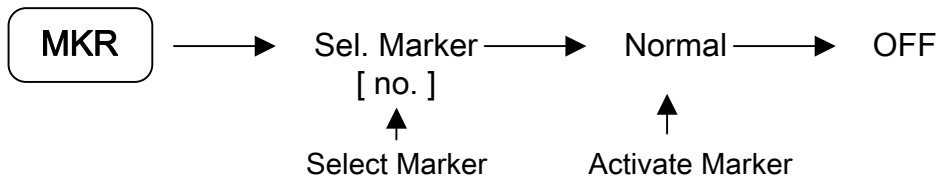

Setting the MKR Trace

The marker can be settable trace “A” or “B”. (ref : Trace Functions 5-47)

By performing the following key operations, the trace for marker position and active marker.



Setting the Marker Readout Mode

Access the following menu keys that allow you to change the active marker readout.

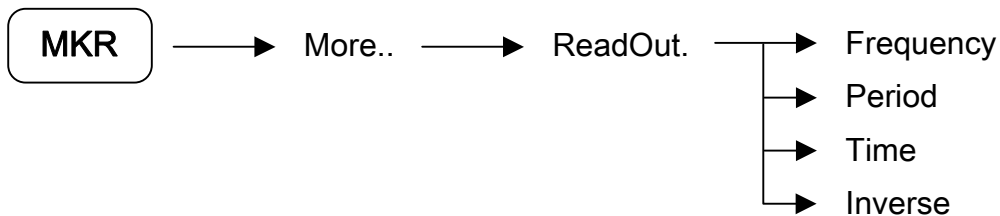

Frequency : Sets the marker readout to Frequency.

This is active in non-zero spans.

Period : Sets the marker readout to Period.

Displays the reciprocal of the frequency.

Time : Sets the marker readout to Time.

Time is active in zero span. (Range : within sweep time)

Inverse Time : Sets the marker readout to Inverse Time.

Displays the reciprocal of time.

Setting the Marker Function

Access the following marker function menu by performing process.

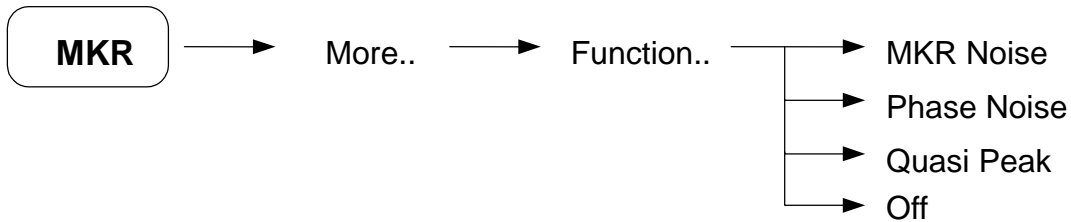

MKR Noise : Reads out the average noise level, referenced to a 1 Hz noise power bandwidth.

Phase Noise : Reads out the carrier to noise ratio. The offset frequency can be settable by numeric keys. (Offset freq. Range : 10 Hz ~ 100 kHz)

Quasi Peak : Reads the quasi peak value in current marker position.
Selectable QP-B and QP_C. (option)

Off : Release marker function.

Setting the Marker Table

When the MKR Table is ON, compress the graticule and displays marker information in a table.

The information includes the marker number, marker type, amplitude and marker readout status.

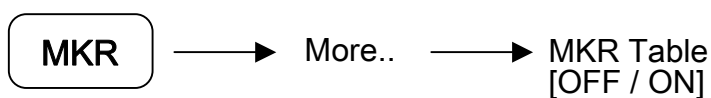

Off All Marker

To delete all markers, perform the following key operations :

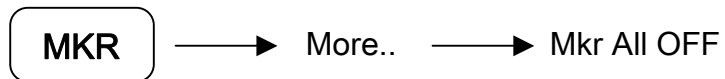

Frequency Counter

The **FC** key is used as the key for measuring precise frequency.

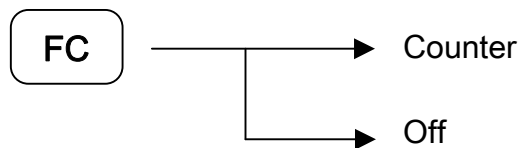

- Counter* : Reads the precise frequency value in current marker position.
Set the marker counter resolution with 1 kHz, 100 Hz, 10 Hz and 1 Hz.
- Off* : Release marker counter.

SETTING PARAMETERS USING MARKER VALUES

The marker value can be set as the parameter value of the observation frequency, reference level, and so on.

This facilitates the observation of the desired waveform.

To set parameters using the marker value, the following settings are possible :

- *Mkr > CF* : Set the marker value to the center frequency.
- *Mkr > CFstep* : Set the marker value to the center frequency step size.
- *Mkr > Start, Stop* : Set the marker value to the start/stop frequency value.
- *Mkr > Ref* : Set the marker value to the reference level.
- *dMkr > Span* : Set the delta marker value to the span.
- *dMkr > CFstep* : Set the delta marker value to the center frequency step size.
- *Mkr > ZoomIN, ZoomOUT* : Fix the marker position and Set the span to 1/2 or 2 of the current span.

In time domain, only *Mkr > Ref* is valid.

MKR > CF / MKR > Ref

Set the current marker frequency or level to the center frequency or the reference level.

To execute the MARKER Shift, perform the following key operations :

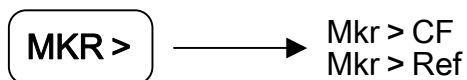

MKR > Start / MKR > Stop

Sets the current marker frequency to the start or stop frequency.

To execute the MARKER Shift, perform the following key operations :

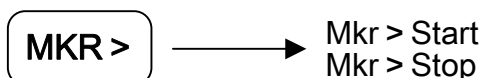

Mkr > CFstep / dMkr > CFstep

Sets the marker frequency to the center frequency step size (resolution determined by up down keys.)

MKR > → Mkr > CFstep

Although this action does not cause any change to appear on the screen, when the center frequency is changed with up down keys, the center frequency is changed with the marker frequency as the step size.

This facilitates observation of harmonics.

dMkr > Span

In the delta marker mode, this operation sets the difference frequency between reference frequency and current marker frequency to span frequency.

MKR > → dMkr > Span

Mkr > ZoomIN / Mkr > ZoomOUT

This function is useable when the current marker frequency is set to the center frequency.

MKR > → Mkr > ZoomIN
Mkr > ZoomOUT

This *Mkr > ZoomIN* function is to change the current span to half the current span.

The *Mkr > ZoomOUT* function changes the current span to two times the current span.

PEAK SEARCH FUNCTIONS

The equipment has the following four marker search functions :

- Peak Search
- Next Peak Search
- Next Left Peak Search
- Next Right Peak Search
- Minimum Search
- Peak to Peak Search
- Marker Track

Peak Search

Peak Search detects the maximum level point from the entire trace and moves activated marker to that point.

Execute peak search by performing the following key operations :

PEAK

When no marker exist, marker 1 is activated.

Next Peak Search

Next Peak search detects the next largest peak relative to the current marker level and moves the marker to that point. (When there are two or more peaks with the same level on the screen, the left most peak is detected.)

Execute Next Peak search by performing the following key operations :

PEAK → Next Peak

The next largest peak can be detected and the marker can be moved to each of those peaks by executing Next Peak Search consecutively.

Peak Left Search/Peak Right Search

PEAK LEFT Search and PEAK RIGHT Search detect the adjacent peak level to the right or left of the current marker and move the marker to that point.

To execute PEAK LEFT Search and PEAK RIGHT Search, perform the following key operation :

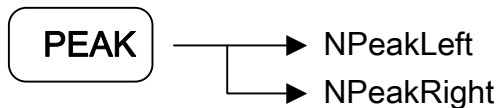

The adjacent peak in the right or left can be detected and the marker moves to that peak by executing *NPeakLeft* or *NpeakRight* menu consecutively.

Marker Track

When the Marker Track is set to ON, the maximum level point of the waveform is always moved to the center position of the horizontal axis.

To use Marker Track, perform the following key operations:

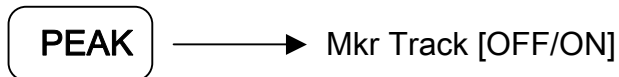

The Marker Track is changed by pressing *Mkr Track* menu.

NOTE : The Mkr Track is operated only, when Trace is *Clear & Write*.

Peak to Peak Search

Find and display the frequency (or time, if in zero span) and amplitude differences between the highest and lowest trace points.

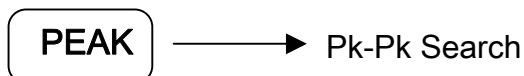

If you search Peak to Peak again, you should current activated marker off.

Setting the Search Parameters

Accesses the following menu keys.

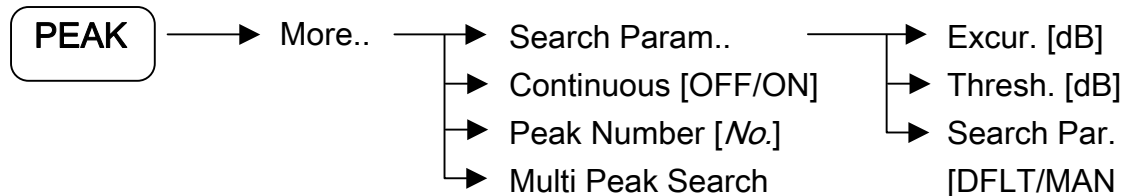

Excur. (Excursion) : Sets the minimum amplitude variation of signals that the marker can identify as a peak.

If a value of 10dB is selected, the marker moves only to peaks that rise and fall more than 10dB above the peak threshold value. Pressing Search Par. [DFLT/MANL] by DFLT, the excursion value and Threshold value is set to 3dB and -100dB each.

For setting the excursion value, use the numeric keys or scroll knob in the Search Par is MNL mode.

Thresh. (Threshold) : Sets a lower boundary to the active trace. The value of the peak threshold level can be changed using the numeric keys or the scroll knob. The threshold level does not influence the trace memory or marker position.

Search Par. [DFLT/MANL] : When set to default(DFLT), the value will change as excursion is 3 dB, Threshold is -100dB.

Continuous[OFF/ON] : Select the search mode between continuously or not.

Peak Number[No.] : Set the number of search marker.
No. : 1- 9

Multi Peak Search : This function is used for multiple peak searching. Instantly the set number of marker will position in order of level of peak on one sweep waveform.
If the only one peak exists with met the condition, all the markers will be gathered on that peak.

TRIGGER FUNCTIONS

The **TRIG** key is the header key for using the trigger function.

Continuous Sweep Mode

When the trigger source is not Free Run, the sweep is executed each time trigger conditions are met. When the trigger source is set to Free Run, the sweep is executed continuously.

To set the continuous sweep mode, press the following keys :



Single Sweep Mode

When the trigger source is set to Free Run, the sweep is executed once immediately after the Single key is pressed. When the trigger source is not Free Run, the sweep is executed only once when the trigger conditions are met.

To set the single sweep mode, press the following keys :

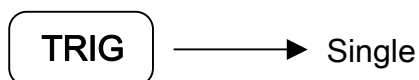

Trigger Source

The equipment trigger mode can be divided into Free Run and Trigger. When trigger source is set to Free Run, we call not Triggered Mode or Free Run mode. Otherwise, Trigger Source is not Free Run, Triggered Mode. In the Triggered mode, Video, Line or External can be selected as the trigger source. To select the TRIGGER SOURCE, perform the following key operations :

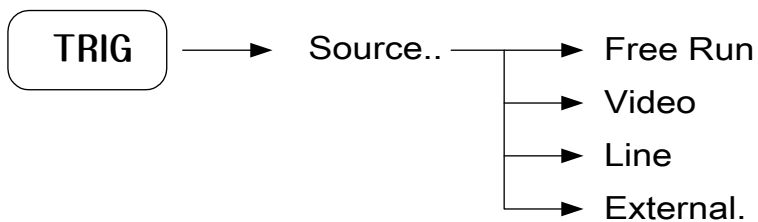

Video Trigger

This function is used in ZERO SPAN mode. (ref : Setting Zero Span 5-11) When the Video Trigger source is selected, the sweep is started in synchronization with the positive leading edge of the detected waveform that is greater than trigger level. To select trigger level, perform the following key operations.

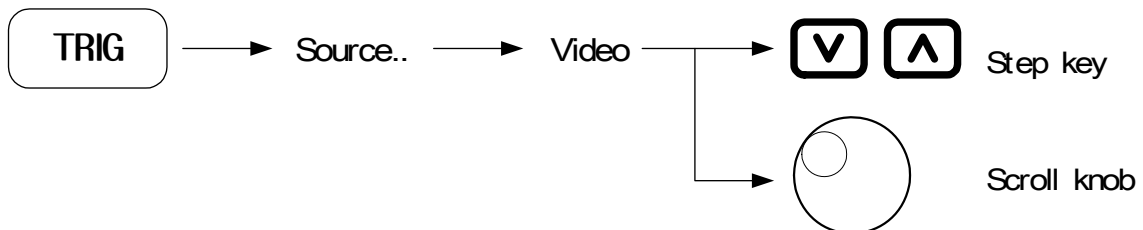

The trigger level is controlled by the step up-down keys or the scroll knob. The trigger level is indicated by displaying the trigger level marker(→) on the screen.

Line Trigger

This function starts sweep in synchronization with AC power line frequency. Line trigger is conveniently used to observe power line-related waveforms. With the line trigger function, the trigger level is not active.

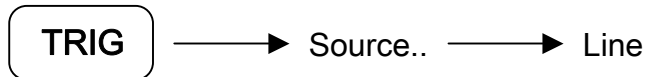

External Trigger

This function starts sweep in synchronization with the external trigger source. Sweep is started in synchronization with the positive leading edge of the signal waveform input to the EXT TRIG input connector on the rear panel. Trigger execution requires TTL input signals.



Trigger Delay

When the trigger mode is set to Triggered mode (Trigger source is selected as Video, External or Line only) the trigger point is usually positioned at the left end of the screen. However, this means that it is not possible to see the waveform before the trigger point and the waveform beyond the right end of the screen. With the equipment, a waveform before (or after the end of the display) the trigger point can be displayed by changing the delay time.

NOTE : Trigger delay works in Zero Span mode only.

To set the delay time perform the following key operations :

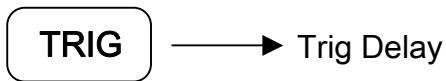

The delay time is set numeric keys, the scroll knob and the step up-down keys in zero span mode. Range of delay time is –sweep time to +sweep time.

A minus value of delay time means the Pre-Trigger mode is used. It means shows the waveform of before trigger point.

A plus value of the delay time means the Post-Trigger mode is used. It means shows the waveform of after trigger point.

Select Trigger Edge

Select the type of trigger edge.

Two trigger edge type : Fall , Rise

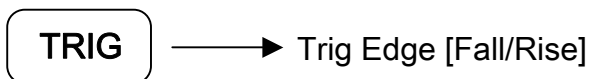

NOTE : Trigger Edge function is operating in Fast Zero mode. Fast Zero mode is zero span lower than 2ms sweep.

Time Gate

When set to Time Gate ON, the video signal that is digitized is controlled by the gate circuitry. The gate circuitry switches between two states.

When the gate is “open”, the normal video signal of the analyzer is passed through the video filters to the peak detectors and digitizer of the analyzer. When the gate is “closed”, the video filters, peak detectors and digitizer are given a signal at the bottom of the display.

The gate function requires that a gate trigger signal be connected to the EXT TRIG (TTL) input on the rear panel. When the gate function is on, the stage of the gate appears at the SWP Gate (TTL) rear panel connector.

The TTL high output indicates that the gate is open.

The gate output signal is only valid while the analyzer is sweeping.

You can adjust the gate delay and gate length using an oscilloscope to view the gate out signal.

Time Gate Menu

Accesses the following menu keys that allow you to set up various gate parameters.

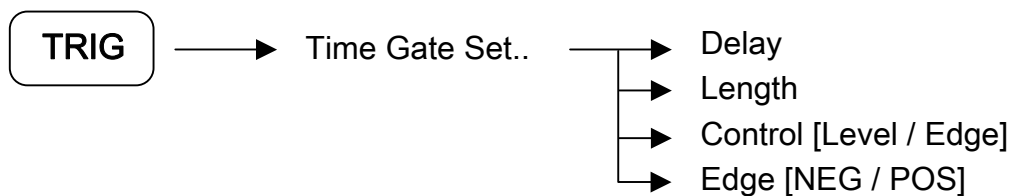

Delay : Control the length of time from the trigger until the gate is turned on.

Length : Controls the length of time that the gate is on when using edge triggering to control the gate.

Control [Level/Edge] : Allows you to select between Edge and Level triggering of the gate, Control Type [Edge] opens the gate in response to an edge trigger on the trigger input after a delay set Delay. The gate stays open for the selected Time Gate Length. When Control Type [Level] is selected, the gate is open as long as the trigger input is true, as defined the Level [TTL] is high.

Edge [NEG/POS] : Sets the polarity for edge triggering of the gate. When *Edge [POS]* is pressed, a positive-going edge will trigger, after the delay set with the *Delay* key, when *Edge [NEG]* is pressed, a negative-going edge will trigger.

COUPLED FUNCTION

The four functions of RBW, VBW, Sweep Time and Input Attenuation are initially set to AUTO so the equipment can automatically select the optimum setting.

There are two hard keys related to the Coupled function.

- **CPL** : Coupling function
- **AMPL** : Amplitude function

All Auto Function

The coupled function has two modes. One is the Auto mode, the other one is the Manual mode.

In order to operate the Auto Mode, perform the following key operations.

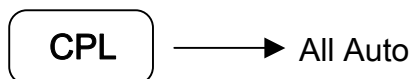

The input attenuator is Automatically set to optimum value according to the reference level.
(ref : Input Attenuator 5-41)

Reference Level Range	Attenuation Auto
25.1 dBm to 30.0 dBm	40
20.1 dBm to 25.0 dBm	35
15.1 dBm to 20.0 dBm	30
10.1 dBm to 15.0 dBm	25
5.1 dBm to 10.0 dBm	20
0 dBm to 5.0 dBm	15
0 dBm to -4.9 dBm	10
Less than -5 dBm	5

Setting the Resolution Bandwidth(RBW)

(1) Auto Mode

The RBW, Sweep Time, and VBW parameters are to Auto so that even if the frequency span is varied, the respective parameters are automatically set to the optimum values so frequency and level measurement errors do not occur.

The following table shows the RBW, VBW, and sweep time for various span ranges.

Frequency Span	RBW	VBW	SWEEP TIME
100 Hz ~ 9.9 kHz	300 Hz	300 Hz	The sweep time is calculated using the Span, RBW, VBW values to option the lowest sweep time while maintaining accuracy.
10 kHz ~ 99.9 kHz	1 kHz	1 kHz	
100 kHz ~ 299.9 kHz	3 kHz	3 kHz	
300 kHz ~ 1.99 MHz	10 kHz	10 kHz	
2 MHz ~ 5.99 MHz	30 kHz	30 kHz	
6 MHz ~ 19.99 MHz	100 kHz	100 kHz	
20 MHz ~ 59.99 MHz	300 kHz	300 kHz	
60 MHz ~ 199.99 MHz	1 MHz	1 MHz	
200 MHz ~ < 1.5 GHz	3 MHz	1 MHz	

(2) Manual Mode

In order to set RBW in the manual mode, perform the following key operations :

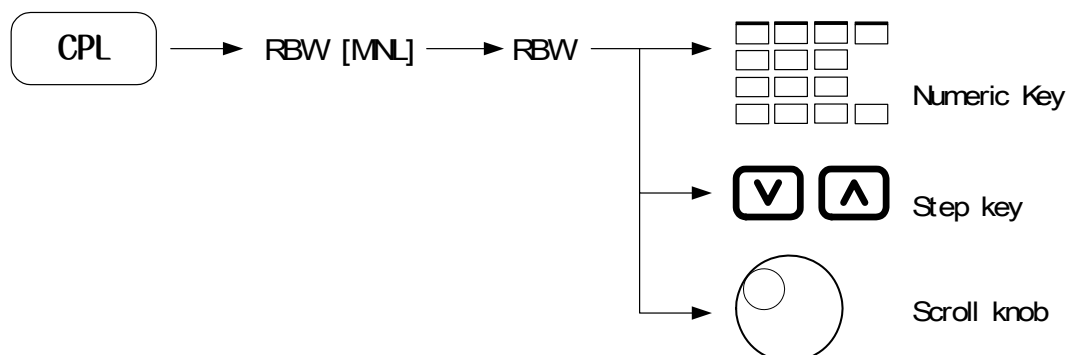

If VBW is AUTO the value is varied depend on the value of RBW. But the RBW value was not varied even changed the value of VBW.

Setting the Video Bandwidth(VBW)

(1) Auto Mode

When VBW is set to AUTO, the VBW is set according to the RBW value.

(2) Manual Mode

To set the VBW, perform the following key operations :

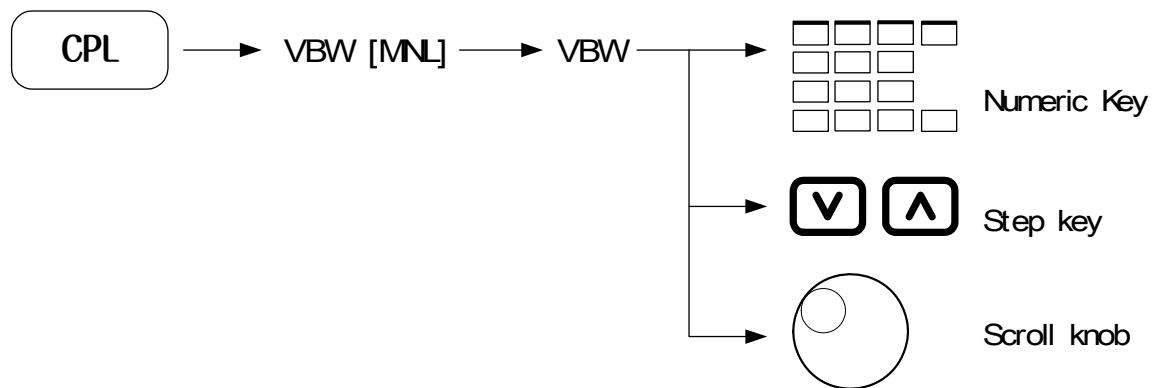

When wanting to average the noise by making the VBW narrow without regard to RBW set value, or when wanting to make the VBW wide to observe the waveform of signals modulated at a high frequency, use MANUAL setting. The VBW value can be manually set be one of following values.

[1 Hz, 3 Hz, 10 Hz, 30 Hz, 100 Hz, 300 Hz, 1 kHz, 3 kHz, 10 kHz, 30 kHz, 100 kHz, 300 kHz, 1 MHz, NONE(3 MHz)]

NOTE : When $VBW \geq RBW$ is set, noise is not averaged and the sweep speed is increased.

Selecting the Sweep Time

To set the sweep time, perform the following key operations :

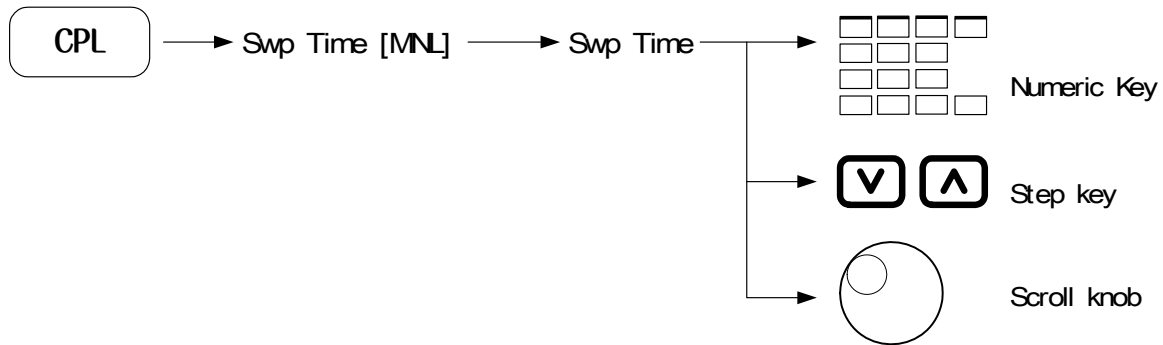

The following shows the Auto Sweep Time Range :

- Not the Zero Span : 20 ms ~ 1000 sec
- Zero Span : 25, 50, 100, 200, 500 us, 1, 2, 5 ms ~ 15 sec

Input Attenuator

To set the input attenuator, perform the following key operations :

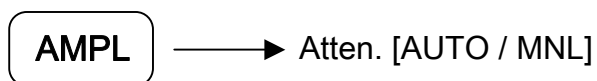

1) Auto Mode

When a signal is input with the same level as the reference level, the input attenuator value in the AUTO mode is controlled so that high accuracy measurements can be made without being influenced by gain compression and the noise level can be reduced.

While Auto is selected, the input attenuator is Automatically set to optimum value according to the reference level.

Reference Level Range	Attenuation Auto
25.1 dBm to 30.0 dBm	40
20.1 dBm to 25.0 dBm	35
15.1 dBm to 20.0 dBm	30
10.1 dBm to 15.0 dBm	25
5.1 dBm to 10.0 dBm	20
0 dBm to 5.0 dBm	15
0 dBm to -4.9 dBm	10
Less than -5 dBm	5

2) Manual Setting

However, when you want to measure a low level signal by raising the sensitivity, set the input attenuator manually as shown in the table below :

Reference Level Range	Attenuation Manual
+30 dBm to -55 dBm	55
+30 dBm to -60 dBm	50
+30 dBm to -70 dBm	40
+20 dBm to -80 dBm	30
+10 dBm to -90 dBm	20
0 dBm to -100 dBm	10
-10 dBm to -110 dBm	0

A small input attenuator value can be used when the RF input level is -10dBm or less.

DISPLAY FUNCTIONS

The equipment provides functions related to the screen display, such as Display line, Threshold line, Screen Title, Annotation and Graticule.

- Display Line : Displays the horizontal line top of the graticule.
- Threshold Line : Displays the horizontal line top of the graticule.
- Screen Title : Edit the title of screen on the top of the screen.
- Graticule : Displays the horizontal line top of the screen.
- Annotation : Displays the state of waveform in the annotation window.
- White Mode : Economy mode for screen save and printing.

Display Line

The Display Line is a horizontal cursor line that runs across the screen for making level comparisons. It can be set between the reference level and the lowest level with the numeric key or step key or scroll knob.

In the OFF setting, the display line disappears from the screen.

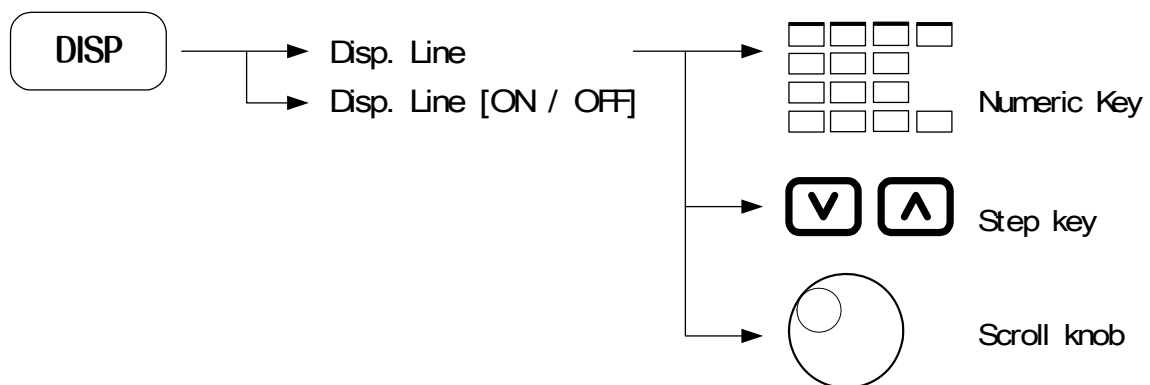

The step size of the step up down key is 1 division of the vertical range.

The step size of the scroll knob is 0.1 dB.

Threshold Line

The Threshold Line is a horizontal line such that the waveform is displayed above the threshold line. It can be set between the reference level and the lowest level with the numeric keys or step keys or scroll knob. In the OFF setting, the threshold line disappears from the screen.

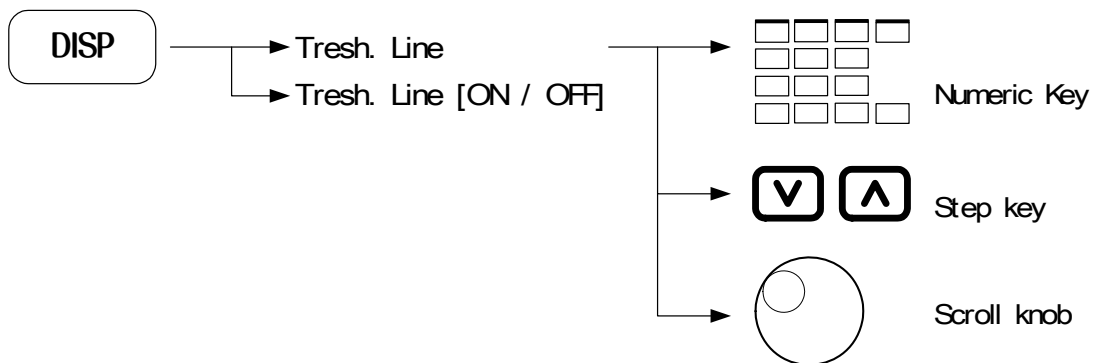

The step size of the step up down keys is 1 division of the vertical range.

The step size of the scroll knob is 0.1 dB.

Screen Title

A title of display spectrum or waveform can be labeled with this function.

The input screen title can be used for a printer and file function. (ref : Filename 5-55)

To make or edit the screen title, perform the following key operations :

When *Screen Title..* menu is pressed, enter the Edit mode and changed in screen title area, also edit menu appeared in soft menu area. In Edit mode all hard key will suspended. Edit menu helps to edit the screen title.

Scroll knob or number key will clear the old screen title. If you do not clear the old title but only edit, first you should press step key. Move cursor to edit position.

Scroll knob is used for selecting the character for input. The character bar appears in Status Window in a lower part of screen and scrolled by scroll knob.

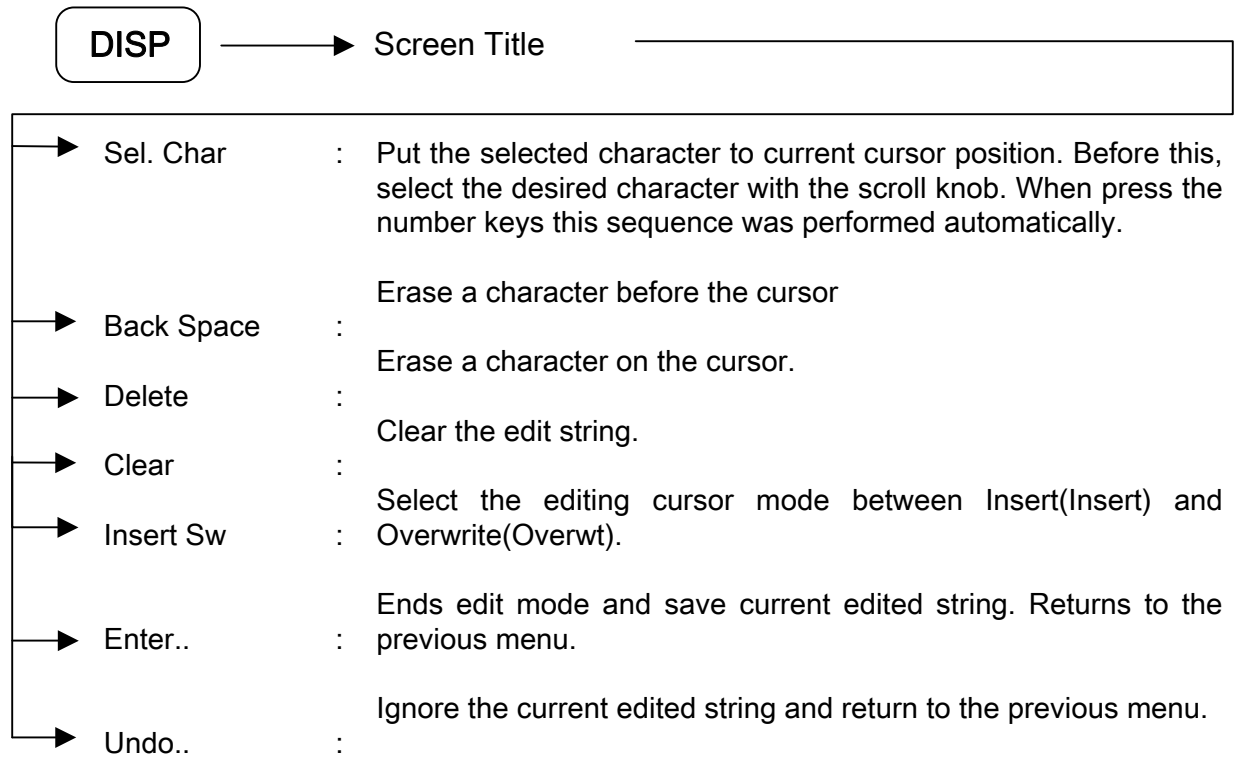

Graticule

This menu toggles the graticule ON or OFF.

To delete the graticule on the screen, perform the following key operations :

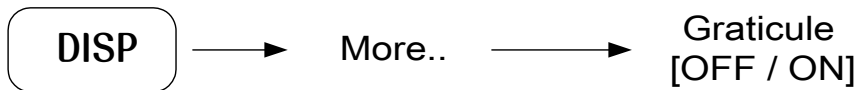

Annotation

This key annotation toggles ON or OFF.

To delete the annotations on the screen, perform the following key operations :

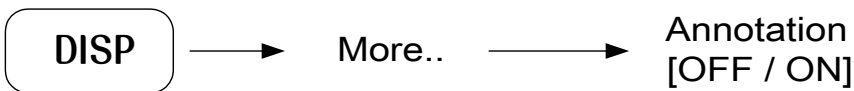

White Mode

Change the screen background color for saving the ink or toner.

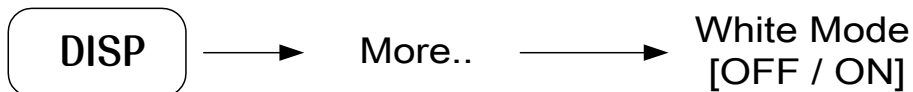

Min Hold

On each sweep, the new data of each horizontal point is compared with previous data. The unit stores and displays the level with the smaller value.

Thus the display accumulates the minimum values for each point.

TRACE → Min Hold >> [A] <<

mA was displayed in Annotation Window.

View

When this key is pressed, the Trace leaves the normal write mode.

The unit displays the contents of the selected trace memory at that time.

To return to the normal write mode, push CLR & WRT again.

TRACE → View >> [A] <<

VA was displayed in Annotation Window.

Blank

When this key is pressed, trace data is erased from the screen, but the content of the memory still remains.

The trace can be redisplayed by selecting VIEW function.

TRACE → Blank >> [A] <<

BA was displayed in Annotation Window.

Averaging Function

The digital averaging function calculates the average data at each vertical axis point for each sweep and displays the results.

The averaging function improves the S/N ratio depending on the averaging rate and the number of sweep repetitions. To use the averaging function, perform the following key operations :

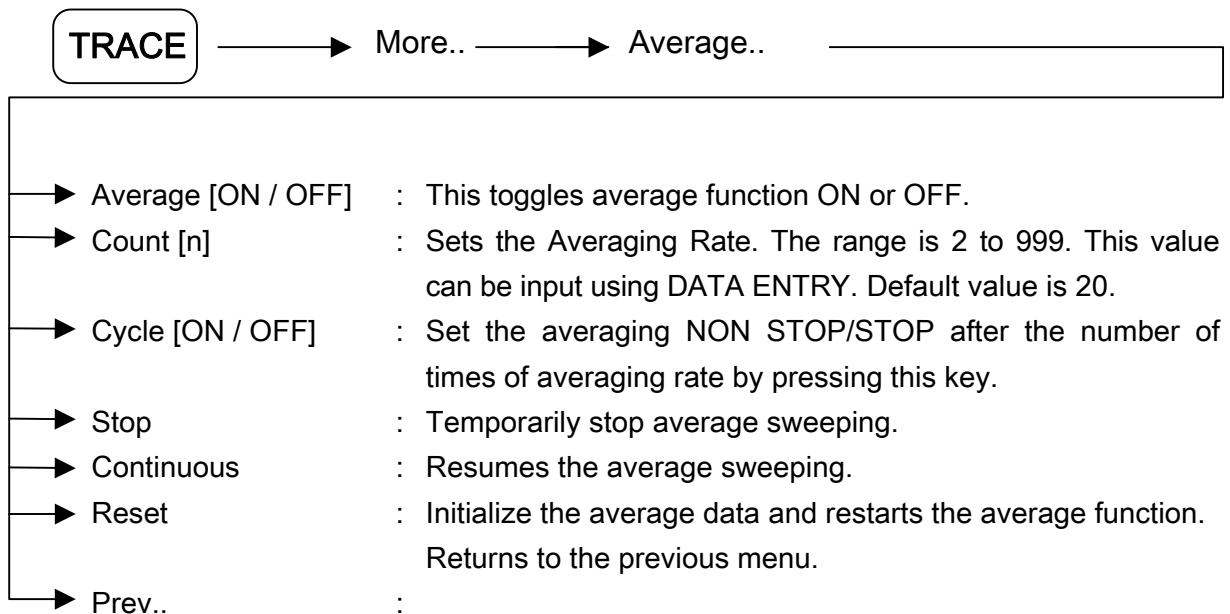

Averaging by video filter has the disadvantage that the sweep time becomes longer when the video bandwidth is narrowed to improve the averaging effect.

On the other and, digital video averaging smoothes the trace display by averaging the digital data after analog to digital conversion at each sweep, without narrowing the video bandwidth (VBW). Since the video bandwidth (VBW) gets comparatively wider and the time required for each sweep can be shortened, the entire spectrum image can be verified quickly and a repetitive sweep can be stopped when the required smoothing has been obtained.

Detection Mode

The equipment provides the following five detection modes.

- Normal
- Sample
- Pos Peak
- Neg Peak
- Average

Select the detection mode by performing the following key operation :

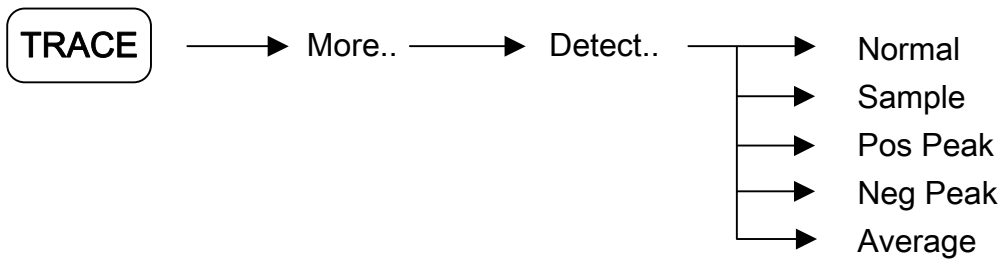

The equipment uses the oversampling method to acquire video data.

Mode	Contents
Normal	The vertical line of odd number horizontal position displays the maximum value among oversampling data for 1 display point and even number horizontal position displays the minimum value. So in the Normal detection mode, the trace does not trace in the next sweep time, toggling odd and even horizontal maximum or minimum detecting value.
Sample	Stores the instantaneous signal level at each sample point the trace memory. The Sample detection mode is primarily used for noise level measurement, and time domain measurement.
Pos Peak	Compare the maximum level point present between the current display point and next display point, then stores the maximum value in the trace memory corresponding to the current display point.
Neg Peak	Compares the minimum level point present between the current display point and next display point, then stores the minimum value in the trace memory corresponding to the current display out. The Neg Peak detection mode is often used to measure the lower envelope side of a modulated waveform.
Average	reduce the random noise level without reducing the video filter or using the trace average function. This allows averaged displays with faster sweep rates. The Average detection mode stores the average data between Pos Peak and Neg Peak.

Mathematics Mode

To use the trace computation, perform the following key operation :
Display the computation and moving soft menu.

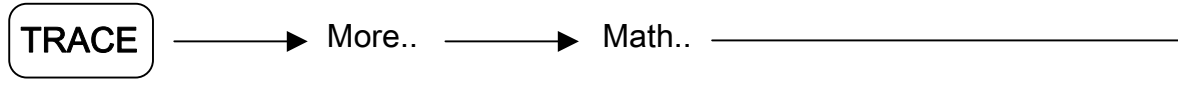

→	A-B → A	:	The result A memory contents becomes the difference between the original A memory, or the sweep data, and the B memory. That is, if Trace A is in the VIEW or BLANK mode, the difference is taken between the A and B memories, and the result stored in A. But if Trace A is in the CLR & WRT mode, it subtracts the B memory data from the current sweep result and save the result in A.
→	B-DL → B	:	When Trace B is in the VIEW or BLANK mode, it subtracts the Display Line from the B memory data, and saves the result in B. But when Trace B is in the CLR & WRT mode, it subtracts the Display line from the current sweep result, and saves the result in B.
→	A+B → A	:	Adds Trace A and Trace B, displays the result as Trace A.
→	A-B+DL → A	:	Turns on the mode that subtracts Trace B from Trace A, adds the Display Line and displays it on Trace A.
→	A EXCH B	:	Exchanges the contents of Trace A memory and Trace B memory.
→	Math [OFF/ON]	:	Adept or not the selected math function.
→	Prev..	:	Returns to the previous menu.

SAVE AND FILE FUNCTIONS

The equipment can save the setup conditions(Parameter), limit data and waveform data (Trace) to an internal Memory, USB Storage or USB Floppy. This data can be recalled and used.

Screen image also saved as BMP & JPG format, but do not recall it.

Internal Memory

The internal Memory uses Flash Disk in the equipment

The internal Memory can save the following data and waveform. (ref : File type 5-54)

Save Parameters and Waveform

The key is the header key for saving parameters and waveforms.

To save the current parameters, waveform data and title to the internal Memory, USB Storage or USB Floppy, press only.

The file type and destination is configured on the FILE Menu. (ref : File Type 5-54) It has two filename generate method, one is Auto generate method, it generates as FILE0000.ext to FILE9999.ext. another is screen title method, it generates filename as the same screen title. (ref : Filename 5-55) But default screen title(*****) is not used as filename. It needs convert to.

File Management

FILE key will display file directory window. To move the selection, use scroll knob or step key. Other Hard key or *Load* menu will close the window.

Perform the following key operations for accessing File Menu.

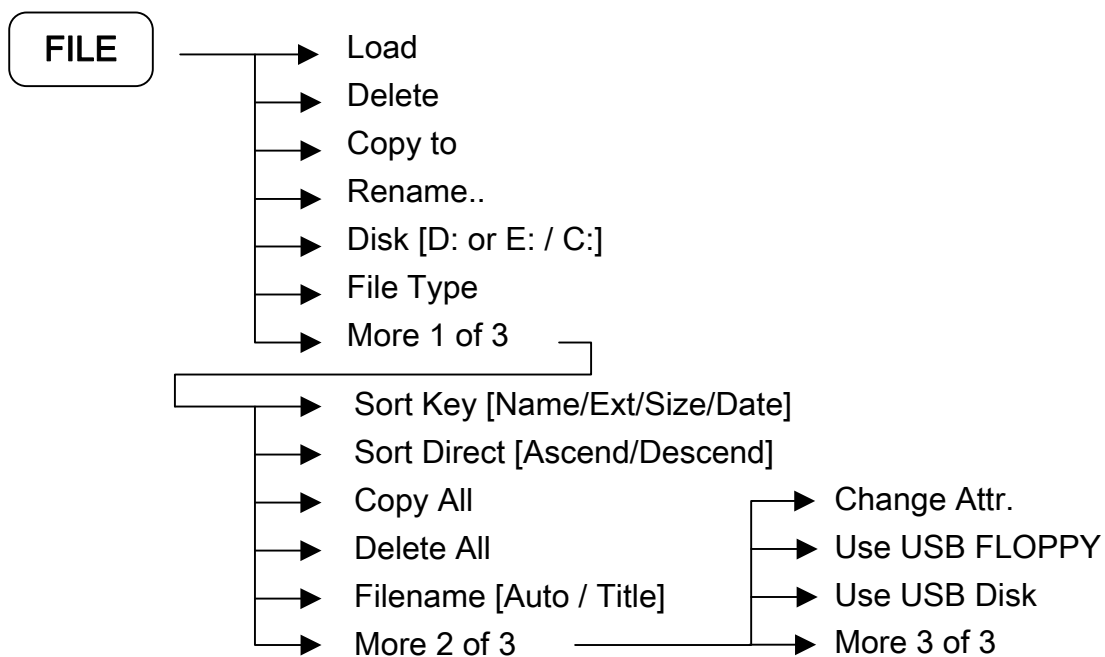

Load : Access menu keys that allow you to load analyzer setups, states, traces limits and corrections into the analyzer from a USB Floppy [D:] Drive, a USB Disk [E:] Drive or internal flash [C:] Drive. To load a file, just press load.

This equipment supports the “8.3-format” filename. (Ex> “8.3-format” filename : XXXXXXXX.YYY) Therefore, file with filename of over 8 is not loaded and correctly displayed.(BMP file and Image file are not loaded)

Delete : Access menu keys that allow you to delete analyzer setups, states, traces and others.

Copy to : Access menu keys that allow you to copy the selected file.

Connect the USB Floppy at the USB Port, then press the **USE USB FLOPPY** key, and then USB Floppy is recognized and you can copy the selected file from D: to C: or from C: to D:.

Connect the USB Storage at the USB Port, then press the **USE USB Disk** key,

and then USB Storage is recognized and you can copy the selected file from E: to C: or from C: to E:.

Disk [D: or E: / C:]: Select Disk drive. File directory of this drive will be displayed. It is also the destination drive of **SAVE**.

When the USB Floppy is connected at the USB Port, if you press the **USE-USB FLOPPY** soft-key, then **Disk [D: / C:]** is set.

When the USB Storage is connected at the USB Port, if you press the **USE-USB Disk** soft-key, then **Disk [E: / C:]** is set.

Rename: Access menu keys that allow you to rename the file name.

For renaming the file, press this key.

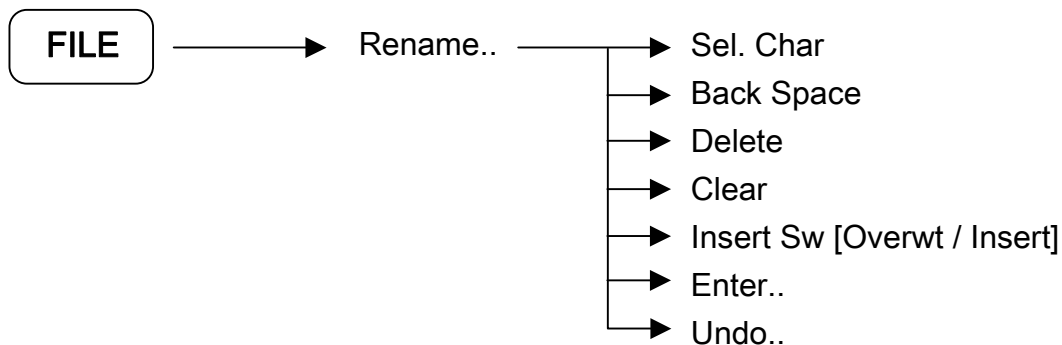

Rename.. menu will change the color of the selected filename, enter the edit mode, other all hard key will suspended. (ref. for edit filename : Screen Title 5-44)

If you want only edit a part of filename, press step key first for move cursor to modify point. Other key operation will clear the old filename.

Enter.. key will save the current modified string to filename and exit this edit mode. **Undo..** key will exit this edit mode without saving.

File Type : Select the file type for display in file directory window. Also the file type for saving when press the **SAVE** key. All(*) File type is only for view the list. Do not select All type for save.

File Type	Extension	Comments
All	*	All Files (Only for View)
State	STS	System status file
Trace	TRC	Trace data file
Limit	LMT	Limit data file
Bitmap	BMP	Screen image file

DTF_DB	DBS	DTF(option) database file
DTFCal	CAL	DTF(option) calibration data file
EmcLimit	LIM	EMC(option) Limit data file
EmcAnt	ANT	EMC(option) antenna data file
EmcCable	CBL	EMC(option) cable data file
EmcXduce	XDU	EMC(option) transduce data file
EmcOther	OTH	EMC(option) user defined data file
DTFDcf	DCF	DTF(option) configuration file
DTFDct	DCT	DTF(option) configuration and trace data file
Jpeg	JPG	Screen image file

Sort Key : Select the sorting field in directory. The kind of filed are filename, extension, size, date. Select field in turn by press *Sort Key*.

Sort Direct : Choose the direction of sorting.

By press *Sort Direct* soft key, select ascend or descend.

Copy All : Copy all the current files in directory to other disk.

- *Disk[D:/C:]* → Current is D: then to C:, Current is C: then to D:.

- *Disk[E:/C:]* → Current is E: then to C:, Current is C: then to E:.

Delete All : Delete all the files in current directory.

Filename : Select filename create mode. In Auto mode, filename was generating sequentially from FILE0000 to FILE9999, anywhere in C:, D: or E:.

In Title mode, filename is screen title. Screen title should be user defined. Default(*****) screen title not be used.

USE USB FLOPPY : When the USB Floppy is connected at the USB Port, if you press the *USE USB FLOPPY* key, then USB Floppy is recognized.

(*Disk [D: or E: / C:]* is set to *Disk [D: / C:]*)

USE USB Disk : When the USB Storage is connected at the USB Port, if you press the *USE USB Disk* key, then USB Storage is recognized.

(*Disk [D: or E: / C:]* is set to *Disk [E: / C:]*)

LIMIT LINE FUNCTIONS

The **LIMIT** key is the header key for using the limit line function

The LIMIT LINE FUNCTION displays two lines, which can be set to show permissible upper and lower bounds on the spectral waveform.

Comparison of measured data with the limit lines is very easy.

● EDIT Limit Line

- 1) *Make Limit.* : appear limit line edit menu.
- 2) *Select [LOW/UP]* : select limit line to edit. The limit line cursor (◇) is displayed.
- 3) *Axis [X/Y]*: select the coordinates for moving cursor.
- 4) Scroll knob, step key : move cursor.
- 5) *Mark Dot*: saving the position of cursor.
- 6) Repeat 3), to 5) for making the limit line.

In editing *Undo* menu delete the current cursor position.

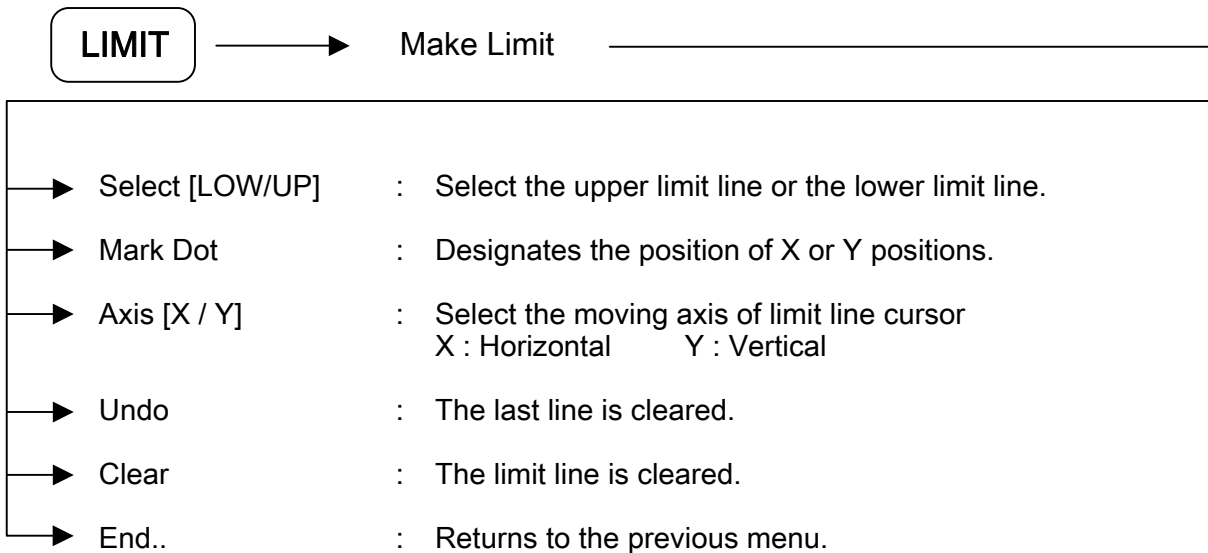

For saving the Limit Line follow the here key operation :

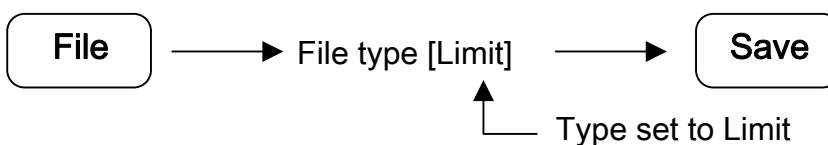

- **Set the PASS/FAIL mode**

When the spectral waveform is within the upper limit line and lower limit, PASS is displayed on the screen. If not, FAIL is displayed on the screen.

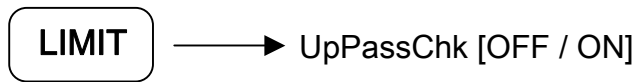

When ON is selected, the upper limit line is checked.



When ON is selected, the lower limit line is checked.

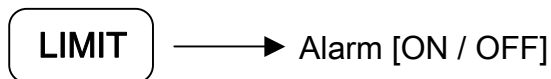

When ON is selected, beep if pass-check fails.

- **Close the Limit Line Function**

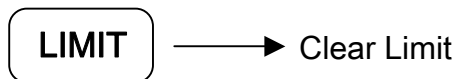

When this key is selected, clear the limit line function.

SYSTEM CONFIGURATION

The system parameters of the equipment can be set depending on the used objective.

The **SYSTEM** hard key is the header key related to set system configuration.

The equipment supports the SA mode (Spectrum Analyzer) and EMC, DTF mode. The SA mode is default and other is for optional.

Printer Configuration

This key is used for setting the print type.

In order to set the configure of printer, perform the following key operations.

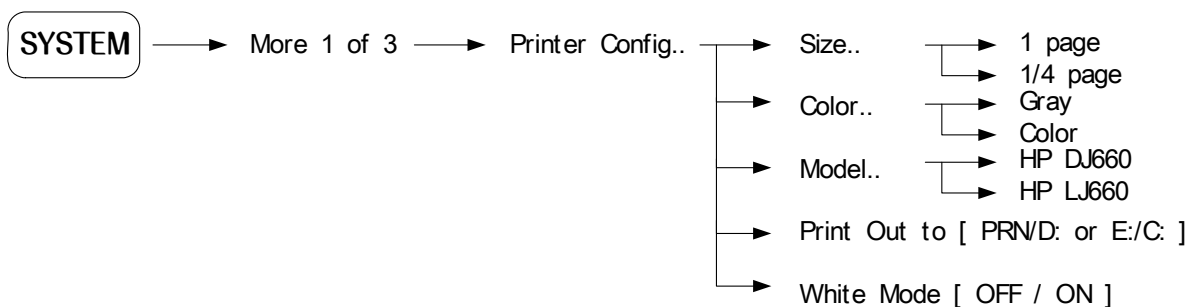

Print Out to menu select the output destination when **PRINT** key was pressed.

In White Mode is ON, save ink or toner by changing background color to White.

Ex.) Two way of saving screen image to bitmap was, the one is press **SAVE** key after set the file type to Bitmap, (**FILE**, *File Type* (4 times or more)) the other is press **PRINT** key after set the *Print Out to* to A: or C:.

Clock Set

Set the date and time by performing the following key operations :

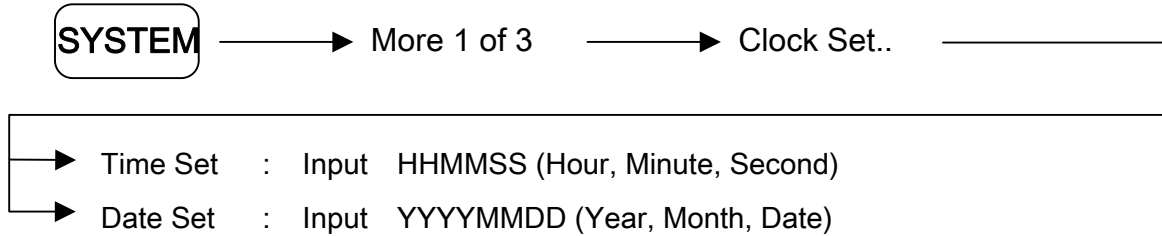

Use numeric keys and ENTER key

GPIB Address Set

Set the GPIB address by performing the following key operations :

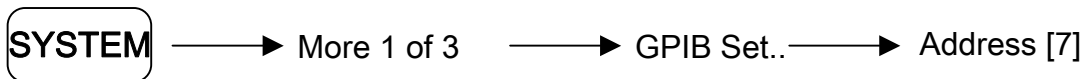

Range : 0 ~ 31

Default : 7

RS-232C Configuration

The system can be remotely controlled using an RS-232C interface.

To set up RS-232C protocol, perform the following key operations :

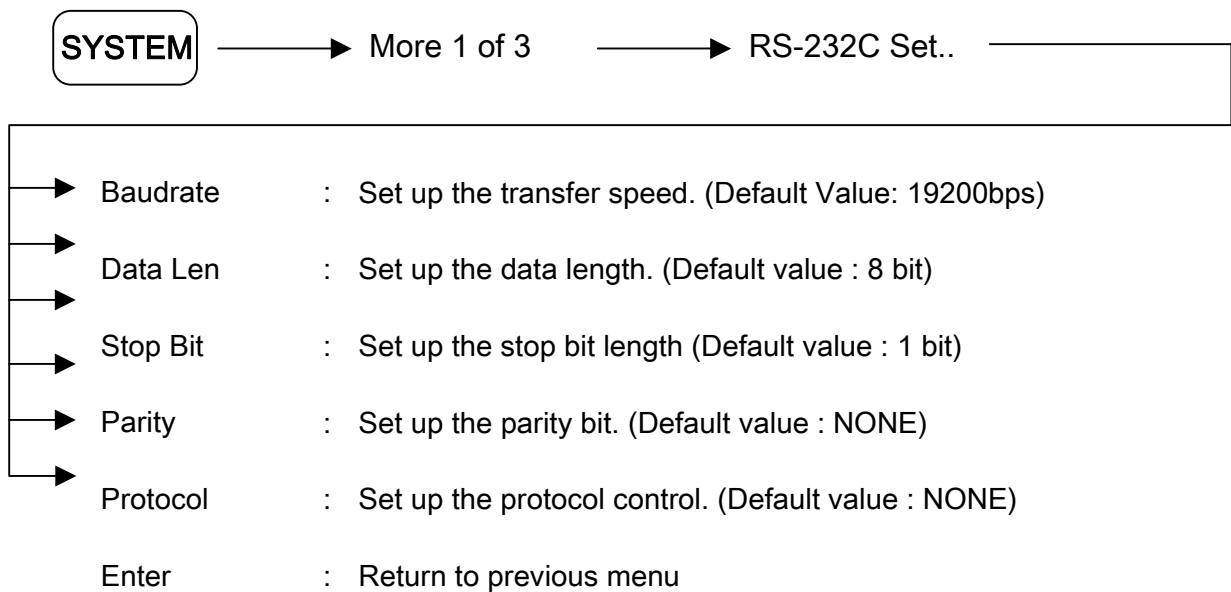

System Information

These key functions are for special functions.

Install.. : for system software upgrade.

Version Info.. : shows the current software version information.

Option Info.. : shows the current installed option information.

Load Fac. Default : set the system to default configuration of shipment.

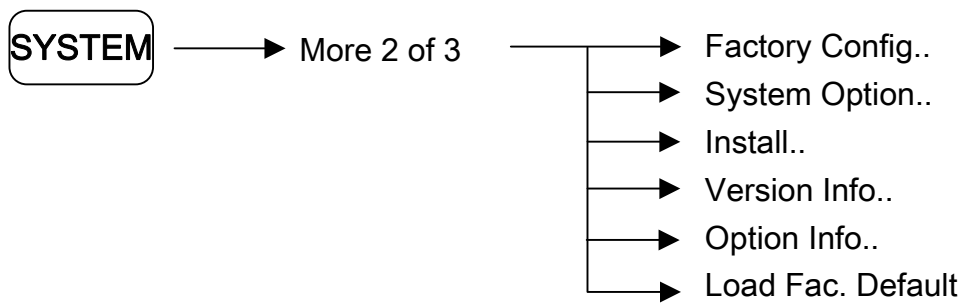

PRESET FUNCTIONS

The preset key is the header key for the preset and calibration functions.

When the **PRESET** key is pressed, the following soft menus are displayed.

- Preset
- Last State
- Alignment Mode
- Power on [Prest / Last]
- Auto Align [OFF / ON]

Preset

Pushing the preset key returns all of the analyzer parameter to the following values.

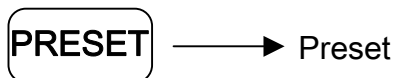

- **Factory Initial Set up**

Center Frequency	: 6.6GHz (2394A) / 13.25GHz (2395A)
Frequency Span	: 13.5GHz (2394A) / 26.5GHz (2395A)
Reference Level	: 0 dBm
Detector	: LOG
Scale	: 10 dB/DIV
Sweep Time	: 20 msec, AUTO mode
RBW	: 3 MHz, AUTO mode
VBW	: 1 MHz, AUTO mode
ATTEN	: 10 dB, AUTO mode (2394A) : 5 dB, AUTO mode (2395A)
Trigger	: Free Run
Marker	: OFF
Display Line	: OFF
Threshold Line	: OFF
Trace Detector Mode	: Pos Peak

Last State

Pressing the Last State key returns all of the analyzer parameters back to the last state values that was the status of before system power off.

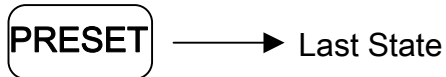

Alignment Mode

When the Alignment Mode is pressed, a soft menu related to the calibration routines are displayed.

Each calibration menu performs the hardware compensation routine to verify the unit operates precisely regardless of any hardware drift.

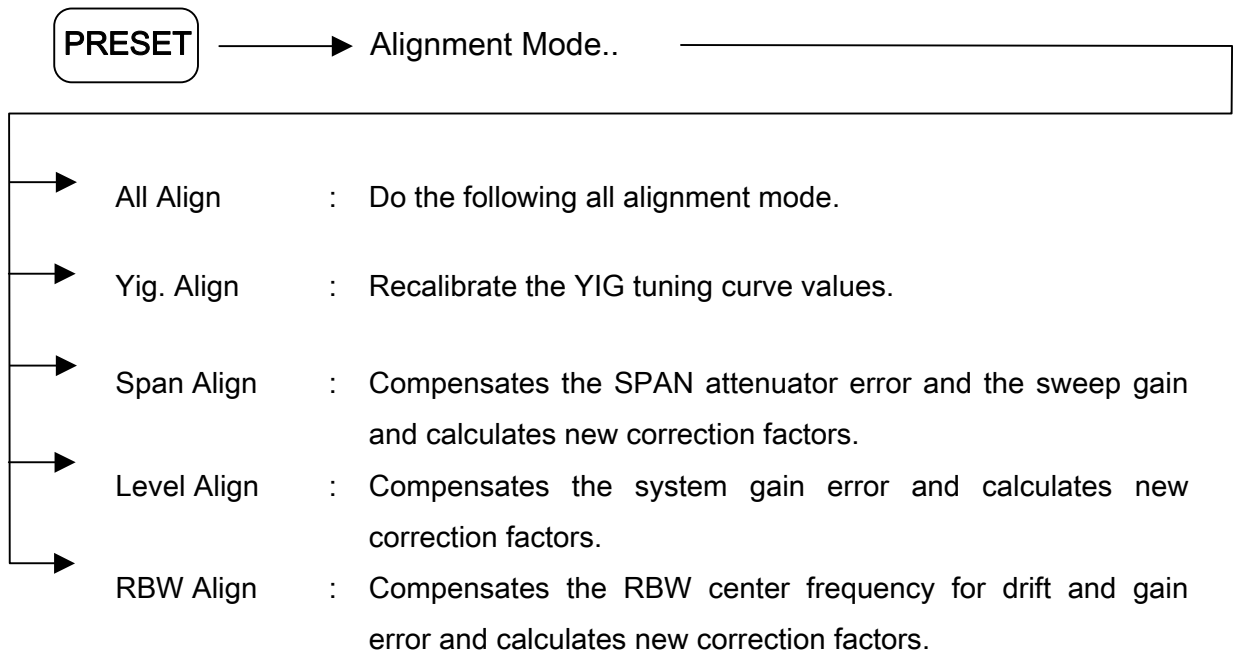

Power ON

This function set the condition of power on state.

When Preset was selected, the power on state is the same as preset state.

When last was selected, the power on state is the set to recent state that was the status of before system power off.



Auto Align

When the Auto Align is on, the calibration routine automatically operates when a temperature calibration is required.

This function does not operate when the Auto Align is off.



AUX FUNCTIONS

The equipment provides analog demodulation and audio monitor functions.

- AM Demodulation
- FM Demodulation
- Audio ON/OFF, Audio level control, Squelch level control.

AM Demodulation

The AM demodulation function displays the amplitude demodulated waveform.

By pressing this key, the horizontal axis changes to the time axis.

The carrier frequency is the center frequency.

To use AM demodulation function, perform the following key operations :

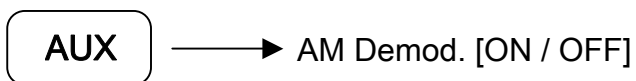

This key toggles AM demodulation ON and OFF.

FM Demodulation

The FM demodulation function displays the frequency-demodulated waveform.

By pressing this key, the horizontal axis changes to the time axis.

The carrier frequency is the center frequency.

To use FM demodulation function, perform the following key operations :



Audio Monitor

The equipment has an internal speaker and phone jack at the front panel.

Audio Sound: used to turn ON the internal speaker.

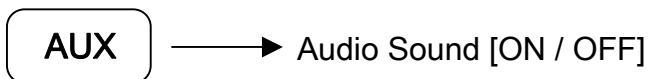

Audio Level: used to control the audio level, which can be adjusted by DATA ENTRY. The audio level has 8 steps (0~ 7). The default value is 3.

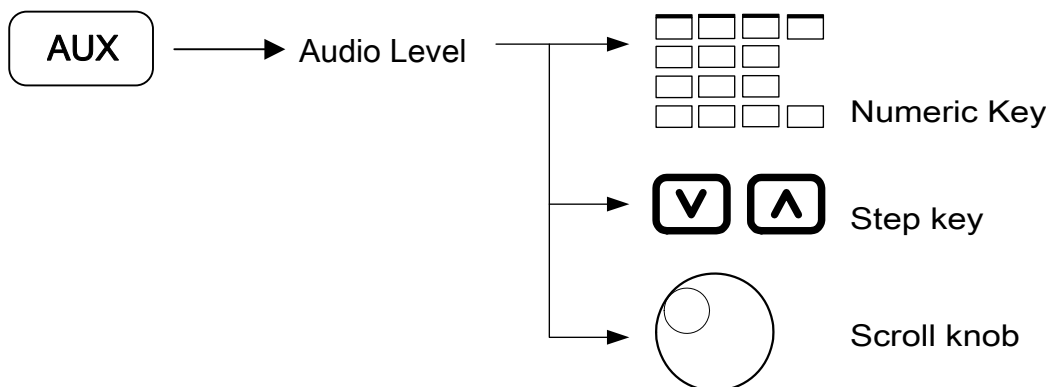

Squelch Lev: used for the squelch function. It has 256 levels, which can be adjusted by DATA ENTRY. The default value is 127.

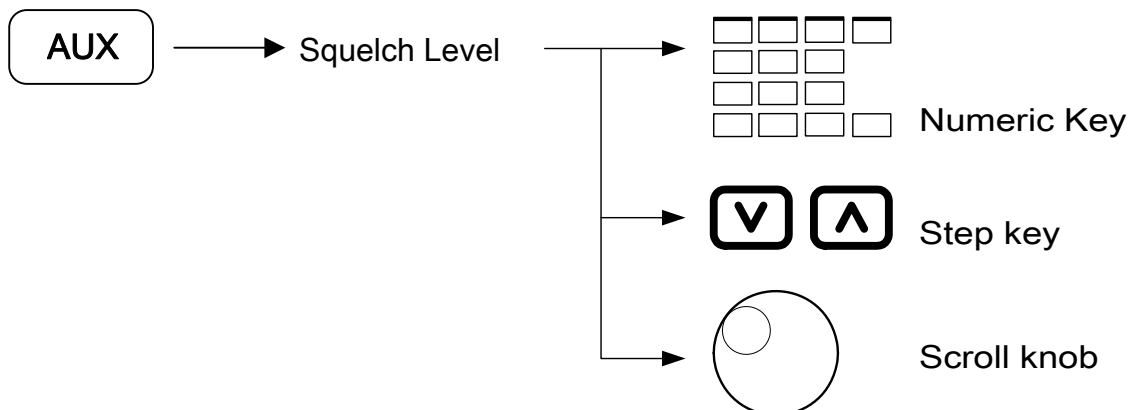

Auto Tune

Detects the maximum peak point in full span and displays its spectrum in the center of the screen and then changes to a small span width.

Last span width set to 1 MHz.



SECTION 6 PERFORMANCE TESTS

In this section, measuring instruments along with setup and operation procedures necessary for conduction performance tests described.

TABLE OF CONTENTS

REQUIREMENT FOR PERFORMANCE TESTS -----	6-3
INSTRUMENTS REQUIRED FOR PERFORMANCE TEST -----	6-4
PERFORMANCE TEST -----	6-6
Reference Oscillator Frequency Stability -----	6-6
Center Frequency Readout Accuracy -----	6-8
Frequency Span Readout Accuracy -----	6-11
Resolution Bandwidth(RBW) and Selectivity and Switching Error -----	6-14
Sideband Noise (Phase noise) -----	6-22
Frequency Measurement Accuracy -----	6-24
Amplitude Display Linearity -----	6-26
Frequency Response -----	6-34
Reference Level Accuracy -----	6-37
Average Noise Level -----	6-40
Second Harmonic Distortion -----	6-43
Input Attenuator Switching Error -----	6-45
Residual FM -----	6-48
3 rd Order Intermodulation -----	6-50
Spurious Response -----	6-53
Local Oscillator Emission -----	6-55
Input VSWR -----	6-57

<BLANK>

SECTION 6 PERFORMANCE TESTS

REQUIREMENT FOR PERFORMANCE TESTS

Performance tests are used as preventive maintenance to prevent degradation of the equipment performance before it occurs. Use the performance tests whenever necessary such as at acceptance and periodic inspection to verify performance after repair.

- Reference oscillator frequency stability
- Center frequency readout accuracy
- Frequency span readout accuracy
- Resolution bandwidth and selectivity and switching error
- Sideband noise (phase noise)
- Frequency measurement accuracy
- Amplitude display linearity
- Frequency response
- Reference level accuracy
- Average noise level
- Second harmonic distortion
- Input Attenuator switching error
- Residual FM
- 3rd Order Intermodulation
- Spurious Response
- Local oscillator Emission
- Input VSWR

Execute the performance tests at regular intervals as preventive maintenance for important evaluation items. We recommend that the performance be inspected regularly once or twice a year. If the specifications are not meet at the performance test, please contact Aeroflex.

INSTRUMENTS REQUIRED FOR PERFORMANCE TEST

Recommended Instrument (Model number)	Required Performance		Test Item
	Item	Specification	
Signal Generator (Agilent 83650B)	Frequency Range Resolution Output Level Range Output Level resolution SSB Phase noise External reference Output	10 MHz~ 50 GHz 1 kHz -20dBm ~ +10dBm 0.02dB ≤ 86dBc/Hz (at 10 kHz offset) 10 MHz	Frequency-span readout accuracy Resolution Bandwidth, selectivity Sideband noise Frequency measurement accuracy Amplitude display linearity Frequency response Reference level accuracy Second harmonic distortion Resolution bandwidth switching error
Agilent 8648C	Frequency Range Resolution Output Level Range Output Level resolution SSB Phase noise	10 kHz~ 3 GHz 1 kHz -20dBm ~ 0dBm 0.1dB ≤ 130dBc/Hz (at 10 kHz offset)	Input Attenuator switching error 3 rd Order Intermodulation
Attenuator (1=Agilent 8494)	Frequency Range Attenuation Repeatability	DC ~ 26.5 GHz 0 ~ 11dB (1 step) ≤ 0.01dB (≤ 0.05dB, 18~26.5 GHz)	Amplitude display linearity Input Attenuator switching error 3 rd Order Intermodulation
(2=Agilent 8496)	Frequency Range Attenuation Repeatability	DC ~ 26.5 GHz 0 ~ 110dB (10 step) ≤ 0.01dB (≤ 0.05dB, 18~26.5 GHz)	
Power Meter (Agilent 437B)	Frequency range Measure Range Power resolution	100 kHz ~ 110 GHz -70dBm ~ +44dBm 0.001dB	Amplitude display linearity Frequency response Reference level accuracy Second harmonic distortion 3 rd Order Intermodulation
Power Sensor (Agilent 8481A)	Frequency range VSWR (max) Power range	10 MHz ~ 18 GHz 1.4 (10 MHz ~ 30 MHz) 1.18 (30 MHz ~ 50 MHz) 1.10 (50 MHz ~ 2 GHz) 1.18 (2 GHz ~ 12.4 GHz) 1.28 (12.4 GHz~ 18 GHz) -30dBm ~ +20dBm	Amplitude display linearity Frequency response Reference level accuracy Input Attenuator switching error Second harmonic distortion 3 rd Order Intermodulation

Recommended Instrument (Model number)	Required Performance		Test Item
	Item	Specification	
50ohm Termination (Agilent 909F)	Frequency Range VSWR	DC ~ 6 GHz (~ 18 GHz) 1.005 (DC ~ 5 GHz) 1.01 (5 ~ 6 GHz) 1.15 (6 ~ 18 GHz)	Average noise level Spurious Response
Power Sensor (Agilent 8481D)	Frequency range VSWR (max) Power range	10 MHz ~ 18 GHz 1.4 (10 MHz ~ 30 MHz) 1.15 (30 MHz ~ 4 GHz) 1.2 (4 GHz ~ 10 GHz) 1.3 (10 GHz ~ 15 GHz) 1.35 (15 GHz ~ 18 GHz) -70dBm ~ -20dBm	Amplitude display linearity
Power Splitter (Agilent 11636A)	Frequency range Input / Output Impedance	DC ~ 18 GHz 50Ω	Frequency-span readout accuracy Frequency measurement accuracy Amplitude display linearity Frequency response Reference level accuracy Second harmonic distortion 3 rd Order Intermodulation
Spectrum Analyzer (Aeroflex 2390A)	Frequency range DANL 2.9 GHz ~ 12 GHz 12 GHz ~ 22 GHz	9 kHz ~ 22 GHz < -130 dBm < -125 dBm	Local Oscillator Emission
Frequency Counter (Agilent 5350B)	Frequency range Resolution 1 Hz ~ 1 MHz 1 Hz 0.1 Hz 0.01 Hz 0.001 Hz Input level (max) Damage level	10 Hz ~ 20 GHz 10 MHz ~ 20 GHz 10 MHz ~ 80 GHz 1 MHz ~ 10 MHz 100 kHz ~ 1 MHz 10 Hz ~ 100 kHz +7dBm (N-type) +10dBm(BNC-type) [50Ω] 1Vrms (BNC-type) [1 MΩ] +25dBm (N-type) 250V (DC ~ 5 kHz) 5.5Vrms (+28dBm)	Reference oscillator frequency Stability Frequency-span readout accuracy Frequency measurement accuracy

Extracts part of performance which can cover the measurement range of the test item.

PERFORMANCE TEST

For test item other than oscillator frequency stability, warming-up the equipment for at least fifteen minutes and the performance after the equipment stabilizes completely.

Also begin measurements after taking the warm-up time of the calibration instrument into full consideration. In addition, the test should be conducted at room temperature little AC power supply voltage fluctuation, and should be free of noise, vibration, dust humidity, etc.

Reference Oscillator Frequency Stability

Frequency stability is tested by measuring the 10 MHz reference oscillator. Stability is determined by measuring frequency variation at ambient temperatures of 0°C and 40°C.

1) Specification

■ Reference Oscillator

- Frequency : 10 MHz
- Aging rate : $\leq \pm 1 \times 10^{-6}$ / year
After 24 hour warm-up at $25^{\circ}\text{C} \pm 5^{\circ}\text{C}$
- Temperature stability : $\leq \pm 2 \times 10^{-6}$ at 0 and 40°C referred to the frequency measured at 25°C

2) Test Instruments

- Frequency counter : 5350B
- BNC Cable : BNC [male] ~ BNC [male]

3) Setup



Figure 6-1. Reference Oscillator Frequency Stability Test

4) Procedure

■ Temperature stability

Test condition : Test this performance in a vibration free variable temperature chamber.

Step	Procedure
1	Set up the equipment in a constant-temperature chamber at 25°C.
2	Set the Line and Power switches on the equipment to ON and wait until the equipment internal temperature stabilizes. (approx. 1.5 hours after the chamber temperature stabilize).
3	When the internal temperature stabilizes, measure the frequency by using the counter with 0.1 Hz resolution.
4	Change the chamber temperature to 40°C.
5	When the chamber temperature and the equipment internal temperature stabilizes, measure the frequency be using the counter.
6	Calculate the stability by using the following equation.
7	Repeat the step 5 to 6 in the 0°C chamber temperature.

$$\text{Frequency Stability}(40^{\circ}\text{C}) = \frac{(\text{counter reading at } 40^{\circ}\text{C}) - (\text{counter reading at } 25^{\circ}\text{C})}{(\text{counter reading at } 25^{\circ}\text{C})}$$

$$\text{Frequency Stability}(0^{\circ}\text{C}) = \frac{(\text{counter reading at } 0^{\circ}\text{C}) - (\text{counter reading at } 25^{\circ}\text{C})}{(\text{counter reading at } 25^{\circ}\text{C})}$$

Center Frequency Readout Accuracy

Add the known frequency which serves as the center frequency reference to the equipment as shown in the figure below and set CF (same value the known center frequency) and SPAN. At this time, check that the difference between reading of the marker readout frequency of peak point, and the CF set value is meet the specification. As shown in the figure, the Signal Generator uses the signal source phaselocked with the same accuracy as the 10 MHz reference oscillator of the Signal Generator.

1) Specification

- Center frequency accuracy : $\pm(\text{Indicated frequency} \times \text{reference frequency accuracy} + \text{span} \times \text{span accuracy} + 0.5 \times \text{RBW})$; after calibration

2) Test Instruments

- Signal Generator : 83650B [Agilent]
- RF Cable : N [male] ~ N [male]
- BNC Cable : BNC [male] ~ BNC [male]

3) Setup

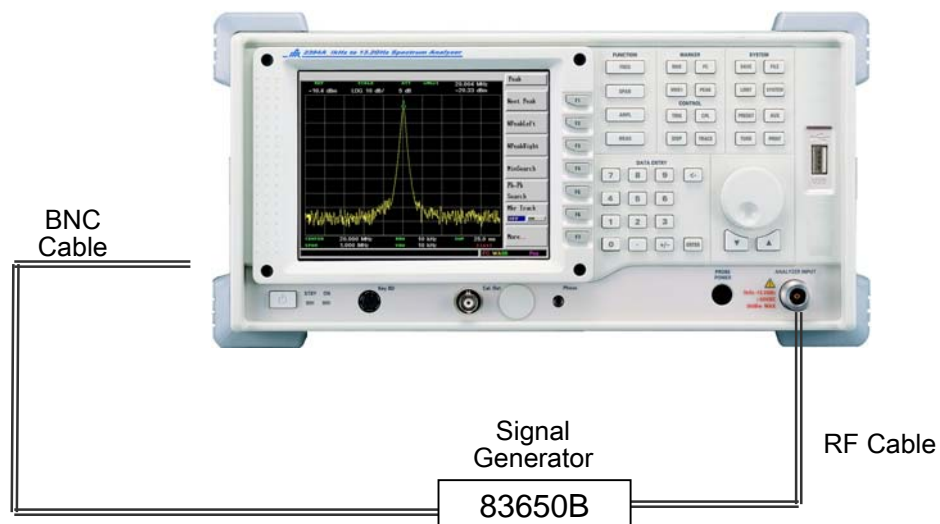

Figure 6-2. Center frequency readout accuracy

4) Procedure

Step	Procedure										
1	Set the power supply switch on the equipment rear panel to ON and then the power switch on the equipment front panel to ON.										
2	Press the <input type="text" value="PRESET"/> , <i>Preset</i> key.										
3	Press <i>Alignment Mode..</i> and then <i>All Align</i> key.										
4	Set the equipment as follows : <table style="margin-left: 20px; border-collapse: collapse;"> <tr> <td style="border: 1px solid black; padding: 2px;"><input type="text" value="Center frequency"/></td> <td style="padding: 2px;">: 1500 MHz</td> </tr> <tr> <td style="border: 1px solid black; padding: 2px;"><input type="text" value="Reference level"/></td> <td style="padding: 2px;">: -10dBm</td> </tr> <tr> <td style="border: 1px solid black; padding: 2px;"><input type="text" value="Couple"/></td> <td style="padding: 2px;">: All Auto</td> </tr> <tr> <td style="border: 1px solid black; padding: 2px;"><input type="text" value="Span"/></td> <td style="padding: 2px;">: 1 MHz</td> </tr> <tr> <td style="border: 1px solid black; padding: 2px;"><input type="text" value="10 MHz REF"/></td> <td style="padding: 2px;">: EXT</td> </tr> </table>	<input type="text" value="Center frequency"/>	: 1500 MHz	<input type="text" value="Reference level"/>	: -10dBm	<input type="text" value="Couple"/>	: All Auto	<input type="text" value="Span"/>	: 1 MHz	<input type="text" value="10 MHz REF"/>	: EXT
<input type="text" value="Center frequency"/>	: 1500 MHz										
<input type="text" value="Reference level"/>	: -10dBm										
<input type="text" value="Couple"/>	: All Auto										
<input type="text" value="Span"/>	: 1 MHz										
<input type="text" value="10 MHz REF"/>	: EXT										
5	Set the Signal Generator output frequency equal to the center frequency (1500 MHz) in the following table : <table style="margin-left: 20px; border-collapse: collapse;"> <tr> <td style="border: 1px solid black; padding: 2px;"><input type="text" value="Frequency"/></td> <td style="padding: 2px;">: 1500 MHz</td> </tr> <tr> <td style="border: 1px solid black; padding: 2px;"><input type="text" value="Power"/></td> <td style="padding: 2px;">: -20dBm</td> </tr> </table>	<input type="text" value="Frequency"/>	: 1500 MHz	<input type="text" value="Power"/>	: -20dBm						
<input type="text" value="Frequency"/>	: 1500 MHz										
<input type="text" value="Power"/>	: -20dBm										
6	Using the marker function, read the marker frequency and check that the value is within the range between the maximum and minimum values shown in the following table.										
7	Repeat the step 4 to 7 for other combination of the center frequency and span according to the combination shown in the following table.										
8	Calculate the Center Frequency accuracy by using the following equation. Center frequency accuracy = $\pm(\text{Measured frequency} \times \text{Reference Oscillator accuracy} + \text{Span} \times \text{Span accuracy} + 0.5 \times \text{RBW})$ ⊗ Reference Oscillator accuracy : ± 2 ppm ... (Default) ± 0.2 ppm ... (HSO option) ⊗ Span accuracy : $\leq \pm 3$ %										

Test Instrument frequency (MG3633A)	Equipment		Measured frequency (MHz)			
	Span	Center Frequenc y	Minimum*	Measured	Maximum *	Accuracy
Frequency : 1500 MHz Output Power Level : -20 dBm	1 MHz	1500 MHz	1499.965		1500.035	
	100 MHz		1496.5		1503.5	
Frequency : 4700 MHz Output Power Level : -20 dBm	1 MHz	4700 MHz	4699.965		4700.035	
	100 MHz		4696.5		4703.5	
Frequency : 9700 MHz Output Power Level : -20 dBm	1 MHz	9700 MHz	9669.965		9700.035	
	100 MHz		9696.5		9703.5	

Note : It's the value of default Reference Oscillator.

Frequency Span Readout Accuracy

Using the setup shown in the figure below, set the frequencies corresponding the 1st and 9th division from the left side of the screen scale with the Signal Generator.

The frequency difference between the peak levels at the 1st and 9th division is equal to the frequency span \times 0.8.

1) Specification

- Frequency span accuracy : $\leq \pm 3\%$

2) Test Instrument

- Signal Generator : 83650B [Agilent]
- RF Cable : N [male] ~ N [male]
- BNC Cable : BNC [male] ~ BNC [male]

3) Setup

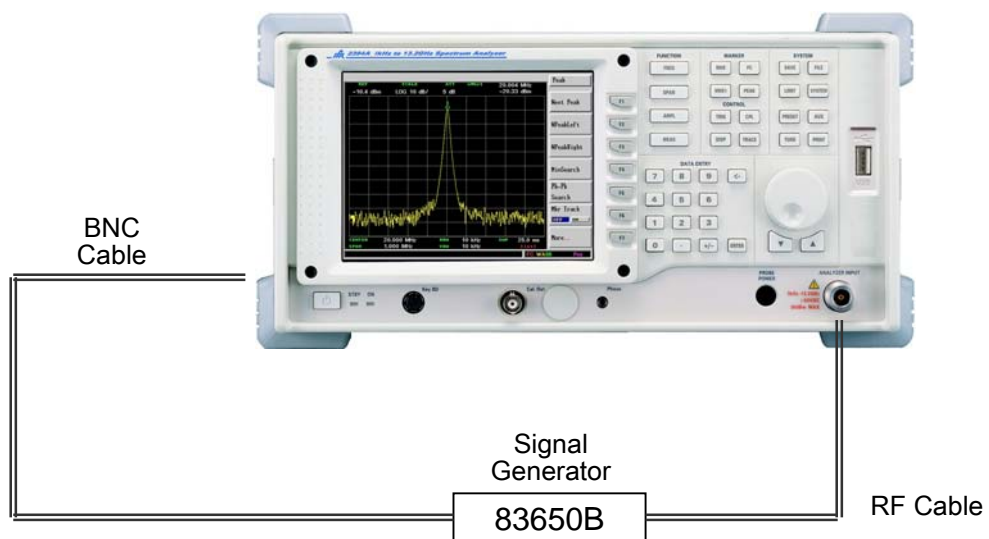

Figure 6-3. Frequency Span Readout Accuracy

4) Procedure

Step	Procedure										
1	Set the power supply switch on the equipment rear panel to ON and then the power switch on the equipment front panel to ON.										
2	Press the PRESET , <i>Preset</i> key.										
3	Press <i>Alignment Mode..</i> and then <i>All Align</i> key.										
4	Set the equipment as follows : <table border="1" data-bbox="370 674 785 913"> <tr> <td>Center frequency</td> <td>: 1500 MHz</td> </tr> <tr> <td>Span</td> <td>: 10 MHz</td> </tr> <tr> <td>Couple</td> <td>: All Auto</td> </tr> <tr> <td>Reference level</td> <td>: -10 dBm</td> </tr> <tr> <td>10 MHz REF</td> <td>: EXT</td> </tr> </table>	Center frequency	: 1500 MHz	Span	: 10 MHz	Couple	: All Auto	Reference level	: -10 dBm	10 MHz REF	: EXT
Center frequency	: 1500 MHz										
Span	: 10 MHz										
Couple	: All Auto										
Reference level	: -10 dBm										
10 MHz REF	: EXT										
5	Set the Signal Generator output frequency equal to the center frequency in the following table : <table border="1" data-bbox="370 1010 798 1104"> <tr> <td>Frequency</td> <td>: 1500 MHz</td> </tr> <tr> <td>Power</td> <td>: -20dBm</td> </tr> </table>	Frequency	: 1500 MHz	Power	: -20dBm						
Frequency	: 1500 MHz										
Power	: -20dBm										
6	Adjust the 83650B output frequency to set the signal peak at the 1 st division from the left and of the screen scale. Record the frequency of F1.										
7	After setting the 83650B output frequency to the F2 frequency adjust it to set the signal peak at the 9 th division. Record the frequency of F2.										
8	Calculate $(F2 \sim F1) / (\text{Span} \times 0.8)$ and check the value is within the specified range shown in the table on the next page.										
9	Repeat the step 5 to 10 for each frequency span with center frequency range between the maximum and minimum values shown in the following table.										
10	Calculate the Frequency Span accuracy by using the following equation :										

$$\text{Frequency span accuracy} = \frac{[\text{Frequency (F2) - Frequency (F1)}] \times 100}{(\text{Span} \times 0.8)}$$

Equipment		Signal Generator (MHz)		Specification ($\pm 3\%$)		
Center Frequency	Span	F2	F1	Minimum Span	Maximum Span	Accuracy
1500 MHz	10 MHz			9.7 MHz	10.3 MHz	
	20 MHz			19.4 MHz	20.6 MHz	
	2000 MHz			1940 MHz	2060 MHz	
	3000 MHz			2910 MHz	3090 MHz	
4700 MHz	10 MHz			9.7 MHz	10.3 MHz	
	20 MHz			19.4 MHz	20.6 MHz	
	2000 MHz			1940 MHz	2060 MHz	
	3000 MHz			2910 MHz	3090 MHz	
6700 MHz	10 MHz			9.7 MHz	10.3 MHz	
	20 MHz			19.4 MHz	20.6 MHz	
	40 MHz			38.8 MHz	41.2 MHz	
	2000 MHz			1940 MHz	2060 MHz	
	3000 MHz			2910 MHz	3090 MHz	
	4000 MHz			3880 MHz	4120 MHz	
6600 MHz			6402 MHz	6798 MHz		

Resolution Bandwidth(RBW) and Selectivity and Switching Error

Resolution Bandwidth (RBW)

When there are two input signals with a frequency difference corresponding to the 3dB bandwidth (of IF final stage) the signals can be resolved as two waveforms. This is called resolution bandwidth.

RBW accuracy and selectivity

The accuracy is defined by the coincidence between setting of RBW and 3dB bandwidth of signal.

The selectivity is defined by the ratio of the filter width, in Hz, at the –60dB point, to the filter width, in Hz, at the –3dB point, as shown in the formula below.

To test the resolution bandwidth and selectivity, first measure the resolution bandwidth (3dB bandwidth), then the 60dB bandwidth and calculate the 60dB/3dB bandwidth ratio.

RBW switching error

The switching error is defined as the shift in amplitude when the RBW filter is switched.

1) Specification

- Accuracy
 - $\leq \pm 20\%$ at 3 dB (300Hz, 1 kHz, 3 kHz, 10 kHz, 30 kHz, 100 kHz, 300 kHz, 1 MHz, 3 MHz)
 - $\leq \pm 20\%$ at 6 dB (9 kHz, 120 kHz) *for Quasi Peak Detection Option
- Selectivity
 - (60dB/3dB Bandwidth) : $\leq 15:1$ (1 kHz, 3 kHz, 10 kHz, 30 kHz, 100 kHz, 300 kHz, 1 MHz, 3 MHz)
 - (60dB/6dB Bandwidth) : $\leq 12:1$ (9 kHz, 120 kHz)
- Switching error : $\leq \pm 1.0$ dB at RBW 3 kHz.

2) Test Instruments

- Signal Generator : 83650B [Agilent]
- RF Cable : N[male] ~ N[male]
- BNC Cable : BNC [male] ~ BNC [male]

3) Setup

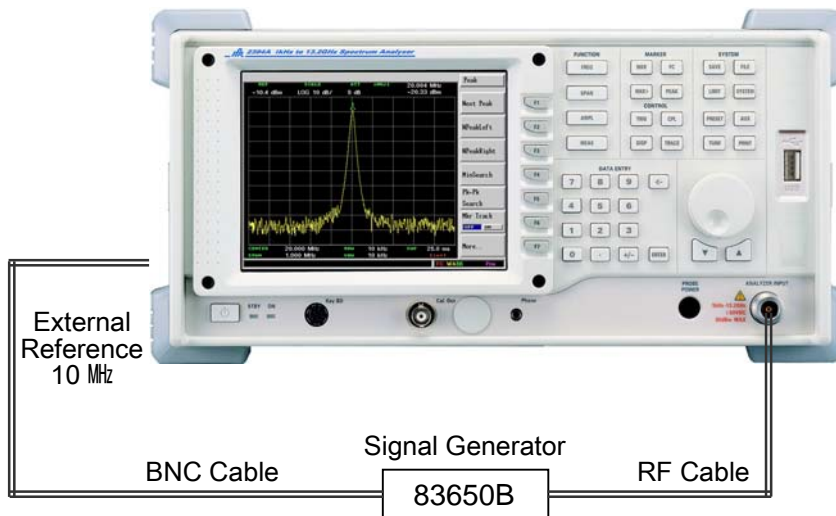

Figure 6-4. Resolution Bandwidth and Selectivity and Error

4) Procedure

- RBW Accuracy

Step	Procedure
1	Press PRESET , <i>Preset</i> key.
2	Press <i>Alignment Mode..</i> and then <i>All Align</i> key.
3	Set up the equipment as shown below :
	Center frequency : 501 MHz
	Span : 10 MHz
	Reference level : -19 dBm
	RBW : 3 MHz
	VBW : 300 kHz
	Scale : 1 dB/Div
	Sweep time : Auto
	10 MHz REF : EXT
4	Set the Signal Generator as shown below :
	Frequency : 501 MHz
	Power : -20 dBm

- 5 Press **PEAK**, **MKR>**, **Mkr>Ref** key and match the peak of the signal trace to the top line Ref Level on the screen.
- 6 Press **TRIG**, *Single* key to execute a single sweep, then check that the single sweep has been completed.
- 7 Press **MEAS**, *X dB Down.., X[dB] Point [3.0]* softkey and then measured value. Press **TRIG**, *Continuous* softkey.
- 8 Repeat the step 5 to 9 for the other resolution bandwidth according to the combinations of resolution bandwidth and frequency span shown in the follow table.
- 9
- 10 Calculate RBW filter accuracy :

$$\text{Accuracy} = \frac{(\text{RBW} - \text{Measured Value})}{\text{RBW}} \times 100\%$$

Equipment			Marker Δ 3dB(6dB) bandwidth			Accuracy	Remark
Center	RBW	Span	Minimum	Measure	Maximum		
501 MHz	1 kHz	2 kHz	800 Hz		1.2 kHz	(6 dB BW)	
	3 kHz	5 kHz	2.4 kHz		3.6 kHz		
	9 kHz	20 kHz	7.2 kHz		10.8 kHz		
	10 kHz	20 kHz	8.0 kHz		12.0 kHz		
	30 kHz	50 kHz	24 kHz		36 kHz		
	100 kHz	200 kHz	80 kHz		120 kHz	(6 dB BW)	
	120 kHz	200 kHz	96 kHz		144 kHz		
	300 kHz	500 kHz	240 kHz		360 kHz		
	1 MHz	2 MHz	800 kHz		1.2 MHz		
	3 MHz	5 MHz	2.4 MHz		3.6 MHz		

3501 MHz	1 kHz	2 kHz	800 Hz		1.2 kHz		(6 dB BW)
	3 kHz	5 kHz	2.4 kHz		3.6 kHz		
	9 kHz	20 kHz	7.2 kHz		10.8 kHz		
	10 kHz	20 kHz	8.0 kHz		12.0 kHz		
	30 kHz	50 kHz	24 kHz		36 kHz		(6 dB BW)
	100 kHz	200 kHz	80 kHz		120 kHz		
	120 kHz	200 kHz	96 kHz		144 kHz		
	300 kHz	500 kHz	240 kHz		360 kHz		
	1 MHz	2 MHz	800 kHz		1.2 MHz		
	3 MHz	5 MHz	2.4 MHz		3.6 MHz		
7402 MHz	1 kHz	2 kHz	800 Hz		1.2 kHz		(6 dB BW)
	3 kHz	5 kHz	2.4 kHz		3.6 kHz		
	9 kHz	20 kHz	7.2 kHz		10.8 kHz		
	10 kHz	20 kHz	8.0 kHz		12.0 kHz		
	30 kHz	50 kHz	24 kHz		36 kHz		(6 dB BW)
	100 kHz	200 kHz	80 kHz		120 kHz		
	120 kHz	200 kHz	96 kHz		144 kHz		
	300 kHz	500 kHz	240 kHz		360 kHz		
	1 MHz	2 MHz	800 kHz		1.2 MHz		
	3 MHz	5 MHz	2.4 MHz		3.6 MHz		

- RBW Selectivity

Step	Procedure														
1	Press PRESET , <i>Preset</i> key.														
2	Press <i>Alignment Mode..</i> softkey and then <i>All Align</i> softkey.														
3	Set the equipment as shown below : <table border="1" style="margin-left: 20px;"> <tr> <td>Center frequency</td> <td>: 501 MHz</td> </tr> <tr> <td>Span</td> <td>: 100 MHz</td> </tr> <tr> <td>Reference level</td> <td>: -10 dBm</td> </tr> <tr> <td>ATT</td> <td>: Auto</td> </tr> <tr> <td>RBW</td> <td>: 3 MHz</td> </tr> <tr> <td>Scale</td> <td>: 10 dB/Div</td> </tr> <tr> <td>Sweep time</td> <td>: Auto</td> </tr> </table>	Center frequency	: 501 MHz	Span	: 100 MHz	Reference level	: -10 dBm	ATT	: Auto	RBW	: 3 MHz	Scale	: 10 dB/Div	Sweep time	: Auto
Center frequency	: 501 MHz														
Span	: 100 MHz														
Reference level	: -10 dBm														
ATT	: Auto														
RBW	: 3 MHz														
Scale	: 10 dB/Div														
Sweep time	: Auto														
4	Set the Signal Generator as shown below : <table border="1" style="margin-left: 20px;"> <tr> <td>Frequency</td> <td>: 501 MHz</td> </tr> <tr> <td>Power</td> <td>: -15 dBm</td> </tr> </table>	Frequency	: 501 MHz	Power	: -15 dBm										
Frequency	: 501 MHz														
Power	: -15 dBm														
5	Press PEAK , MKR> , <i>Mkr>Ref</i> key and match the peak of the signal trace to the stop line Ref Level on the screen.														
6	Press TRIG , <i>Single</i> key to execute a signal sweep, then check that the single sweep has been completed.														
7	Press MEAS , <i>X dB Down.., X [dB] point[60]</i> set key and then measure the X dB Relate.														
8	Press TRIG , <i>Continuous</i> key. Change the RBW filter and measure.														
9	Repeat the step 5 to 9 for the other resolution bandwidth filters and frequency spans according to the combinations of resolution bandwidth and frequency span shown in the follow table.														
10	For 3 dB bandwidth, used the value table (item RBW Accuracy)														
11	Calculate RBW Selectivity :														

$$\text{Selectivity} = \frac{60 \text{ dB Bandwidth}}{3 \text{ dB Bandwidth (or 6 dB Bandwidth)}}$$

Equipment			3dB BW (6dB BW)	60dB BW	Selectivity	Remark
Center	RBW	Span				
501 MHz	1 kHz	20 kHz				(6 dB BW)
	3 kHz	50 kHz				
	9 kHz	100 kHz				
	10 kHz	200 kHz				
	30 kHz	500 kHz				
	100 kHz	2 MHz				(6 dB BW)
	120 kHz	2 MHz				
	300 kHz	10 MHz				
	1 MHz	20 MHz				
	3 MHz	50 MHz				
3501 MHz	1 kHz	20 kHz				(6 dB BW)
	3 kHz	50 kHz				
	9 kHz	100 kHz				
	10 kHz	200 kHz				
	30 kHz	500 kHz				
	100 kHz	2 MHz				(6 dB BW)
	120 kHz	2 MHz				
	300 kHz	10 MHz				
	1 MHz	20 MHz				
	3 MHz	50 MHz				
7402 MHz	1 kHz	20 kHz				(6 dB BW)
	3 kHz	50 kHz				
	9 kHz	100 kHz				
	10 kHz	200 kHz				
	30 kHz	500 kHz				
	100 kHz	2 MHz				(6 dB BW)
	120 kHz	2 MHz				
	300 kHz	10 MHz				
	1 MHz	20 MHz				
	3 MHz	50 MHz				

- RBW Switching error

Step	Procedure																
1	Press <input type="text" value="PRESET"/> , <i>Preset</i> key.																
2	Press <i>Alignment Mode..</i> softkey and then <i>All Align</i> softkey.																
3	Set up the equipment as shown below : <table border="1" style="margin-left: 20px;"> <tr> <td><input type="text" value="Center frequency"/></td> <td>: 100 MHz</td> </tr> <tr> <td><input type="text" value="Span"/></td> <td>: 20 MHz</td> </tr> <tr> <td><input type="text" value="Reference level"/></td> <td>: -10 dBm</td> </tr> <tr> <td><input type="text" value="ATT"/></td> <td>: Auto</td> </tr> <tr> <td><input type="text" value="RBW"/></td> <td>: 3 kHz</td> </tr> <tr> <td><input type="text" value="Scale"/></td> <td>: 10 dB/Div</td> </tr> <tr> <td><input type="text" value="Sweep time"/></td> <td>: Auto</td> </tr> <tr> <td><input type="text" value="10 MHz REF"/></td> <td>: EXT</td> </tr> </table>	<input type="text" value="Center frequency"/>	: 100 MHz	<input type="text" value="Span"/>	: 20 MHz	<input type="text" value="Reference level"/>	: -10 dBm	<input type="text" value="ATT"/>	: Auto	<input type="text" value="RBW"/>	: 3 kHz	<input type="text" value="Scale"/>	: 10 dB/Div	<input type="text" value="Sweep time"/>	: Auto	<input type="text" value="10 MHz REF"/>	: EXT
<input type="text" value="Center frequency"/>	: 100 MHz																
<input type="text" value="Span"/>	: 20 MHz																
<input type="text" value="Reference level"/>	: -10 dBm																
<input type="text" value="ATT"/>	: Auto																
<input type="text" value="RBW"/>	: 3 kHz																
<input type="text" value="Scale"/>	: 10 dB/Div																
<input type="text" value="Sweep time"/>	: Auto																
<input type="text" value="10 MHz REF"/>	: EXT																
4	Set the Signal Generator as shown below : <table border="1" style="margin-left: 20px;"> <tr> <td><input type="text" value="Frequency"/></td> <td>: 100 MHz</td> </tr> <tr> <td><input type="text" value="Power"/></td> <td>: -15 dBm</td> </tr> </table>	<input type="text" value="Frequency"/>	: 100 MHz	<input type="text" value="Power"/>	: -15 dBm												
<input type="text" value="Frequency"/>	: 100 MHz																
<input type="text" value="Power"/>	: -15 dBm																
5	Press <input type="text" value="PEAK"/> , <input type="text" value="MKR>"/> , <i>Mkr > CF</i> key to move the signal peak to the center and the top of the screen.																
6	Press <input type="text" value="MKR"/> , <i>Delta</i> key that in order to set to the marker to delta marker.																
7	Set sequentially RBW and SPAN as shown in the table (300 Hz/2 kHz ~ 3 MHz /15 MHz).																
8	Press <input type="text" value="PEAK"/> key to conduct peak search and move the current marker to the peak point of the signal spectrum.																
9	Read the Δ marker level value.																
10	Repeat the step 7 to 9.																

RBW	Frequency span	Deviation (error)	Remark
300 Hz	2 kHz	0.0	(Reference)
1 kHz	10 kHz		
3 kHz	20 kHz		
10 kHz	50 kHz		
30 kHz	150 kHz		
100 kHz	500 kHz		
300 kHz	1.5 MHz		
1 MHz	5 MHz		
3 MHz	15 MHz		

Sideband Noise (Phase noise)

Sideband noise measured the noise of local oscillator signal measured at an offset from the carrier frequency. It is important to use a signal source with 10dB or better sideband noise performance than the equipment.

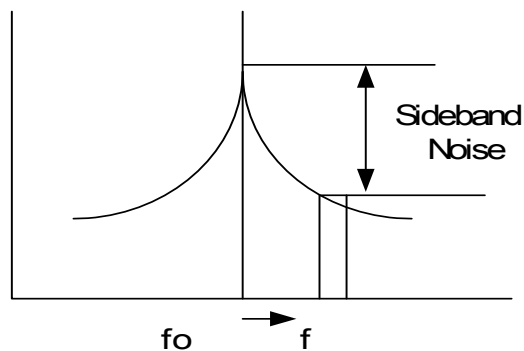

1) Specification

- Sideband noise (phase noise) : $\leq -90 \text{ dBc/Hz} + 20\log N$ for Frequency 3.0GHz
(@ 10 kHz offset, N = LO Harmonic mixing Mode)

2) Test Instruments

- Signal Generator : 8648C
- RF Cable : N[male] ~ N[male]
- BNC Cable : BNC [male] ~ BNC [male]

3) Setup

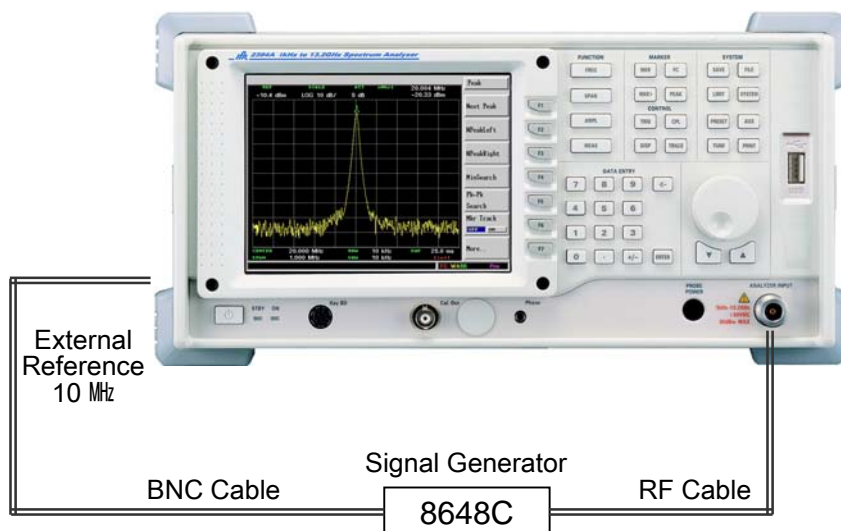

Figure 6-5. Sideband Noise

4) Procedure

Step	Procedure																
1	Press PRESET , <i>Preset</i> key.																
2	Press <i>Alignment Mode..</i> softkey and then <i>All Align</i> softkey.																
3	Set up the equipment as shown below : <table border="1" style="margin-left: 20px;"> <tr><td>Center frequency</td><td>: 1 MHz</td></tr> <tr><td>Span</td><td>: 50 kHz</td></tr> <tr><td>Reference level</td><td>: -10 dBm</td></tr> <tr><td>ATT</td><td>: 0 dB</td></tr> <tr><td>RBW</td><td>: 300 Hz</td></tr> <tr><td>VBW</td><td>: Auto</td></tr> <tr><td>Scale</td><td>: 10 dB/Div</td></tr> <tr><td>Sweep time</td><td>: Auto</td></tr> </table>	Center frequency	: 1 MHz	Span	: 50 kHz	Reference level	: -10 dBm	ATT	: 0 dB	RBW	: 300 Hz	VBW	: Auto	Scale	: 10 dB/Div	Sweep time	: Auto
Center frequency	: 1 MHz																
Span	: 50 kHz																
Reference level	: -10 dBm																
ATT	: 0 dB																
RBW	: 300 Hz																
VBW	: Auto																
Scale	: 10 dB/Div																
Sweep time	: Auto																
4	Set up the 8648C as shown below : <table border="1" style="margin-left: 20px;"> <tr><td>Frequency</td><td>: 1 MHz</td></tr> <tr><td>Power</td><td>: -12 dBm</td></tr> </table>	Frequency	: 1 MHz	Power	: -12 dBm												
Frequency	: 1 MHz																
Power	: -12 dBm																
5	Press PEAK , MKR> , <i>Mkr>CF</i> key and <i>Mkr>Ref</i> to move the signal spectrum peak to the center and the top of the screen.																
6	Press the MKR , <i>Delta</i> that in order to set to the marker to Δ marker.																
7	Set the Δ marker to frequency of 10 kHz and read marker value (amplitude). Calculate Sideband noise. Sideband noise = Measured Value (Δ marker value) – 10log (RBW/1 Hz)																

Example]

Offset frequency	RBW	Measured value	Sideband Noise
10 kHz	1 kHz	-65 dBc	-95 dBc/Hz

* Press **MKR**, *More..*, *Function..*, *Phase Noise* key then phase noise test will be completed.

Frequency Measurement Accuracy

To measure frequency counter accuracy set the Signal Generator and marker point to a position at least 20 dB higher than the noise (or adjacent interference signal) to operate the built-in counter and test the frequency measurement accuracy using the Frequency Counter COUNT ON mode.

1) Specification

- Accuracy : $\leq \pm((\text{Reference frequency accuracy} \times \text{marker frequency}) + (1(\text{resolution error}) + 1(\text{counter error}) \times \text{counter resolution}))$
- Resolution : 1 Hz, 10 Hz, 100 Hz, 1 kHz
- Sensitivity : -70 dBm min
- ※ Reference oscillator accuracy : $\leq \pm 2$ ppm (Default)

2) Test Instruments

- Signal Generator : 83650B
- Frequency counter : 5350B
- Power Splitter : 11636A
- RF Cable 1,2,3 : N [male] ~ N [male]
- BNC Cable : BNC [male] ~ BNC [male]
- Adapter : T-BNC [female]

3) Setup

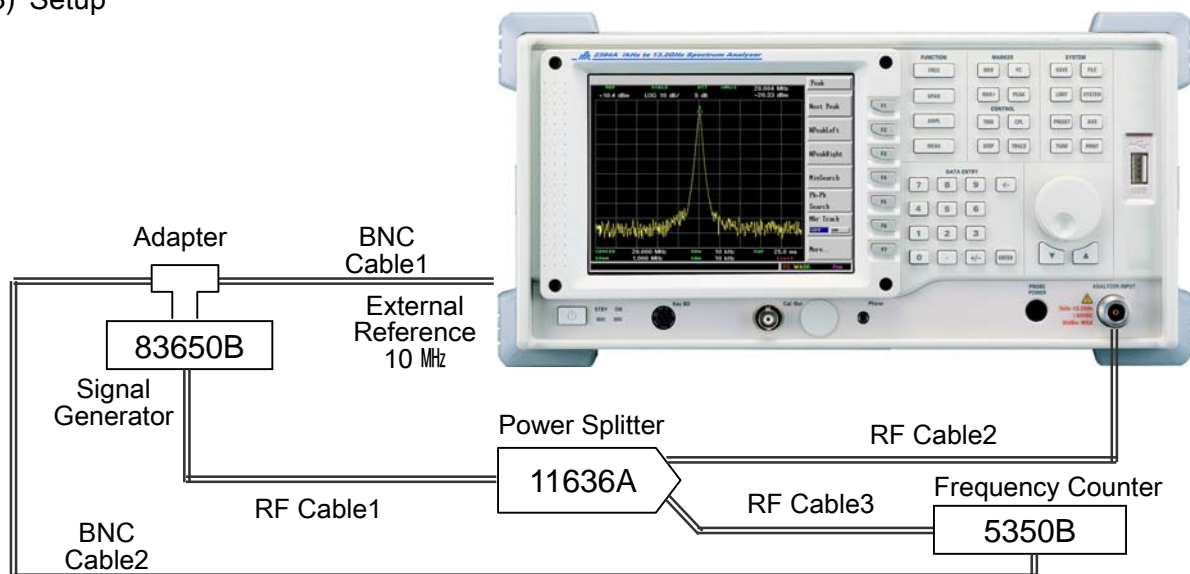

Figure 6-6. Frequency Measurement Accuracy

4) Procedure

Step	Procedure														
1	Press PRESET , <i>Preset</i> key.														
2	Press <i>Alignment Mode..</i> softkey and then <i>All Align</i> softkey.														
3	Set up the equipment as shown below : <table border="1" style="margin-left: 20px;"> <tr> <td>Center frequency</td> <td>: 3000 MHz</td> </tr> <tr> <td>Span</td> <td>: 50 kHz</td> </tr> <tr> <td>10 MHz REF</td> <td>: EXT</td> </tr> <tr> <td>Couple</td> <td>: All Auto</td> </tr> <tr> <td>Reference Level</td> <td>: -20 dBm</td> </tr> </table> <p>Set the Signal Generator as shown below :</p> <table border="1" style="margin-left: 20px;"> <tr> <td>Frequency</td> <td>: 3000 MHz</td> </tr> <tr> <td>Power</td> <td>: -30 dBm</td> </tr> </table>	Center frequency	: 3000 MHz	Span	: 50 kHz	10 MHz REF	: EXT	Couple	: All Auto	Reference Level	: -20 dBm	Frequency	: 3000 MHz	Power	: -30 dBm
Center frequency	: 3000 MHz														
Span	: 50 kHz														
10 MHz REF	: EXT														
Couple	: All Auto														
Reference Level	: -20 dBm														
Frequency	: 3000 MHz														
Power	: -30 dBm														
4	Press MKR , <i>More..</i> , <i>Function..</i> and <i>Counter</i> key to set Frequency Counter ON.														
5	Change the counter resolution to 1 kHz, 100 Hz, 10 Hz and 1 Hz then confirm that the frequency reading specification below table.														

Signal Generator Freq. Level	Equipment		Measured Frequency		Standard Accuracy
	CF	Resolutio n	Marker Frequenc y	Measured Accuracy	
3000 MHz, -30 dBm	3000 MHz	1 Hz 10 Hz 100 Hz 1000 Hz			±(Reference frequency error × marker frequency accuracy + counter resolution ±1 count)
3000 MHz, -70 dBm	3000 MHz	1000 Hz			

Amplitude Display Linearity

This test determines the error per vertical graduation for the LOG display and LINEAR display.

Apply the correct level signal to the RF Input via an external attenuator and measure the error from the attenuation of the attenuator and the Δ marker reading at the trace waveform peak.

1) Specification

- Amplitude display linearity : After automatic calibration
 - LOG : $\leq \pm 1.0$ dB for 5 or 10 dB / div over (RBW \leq 3 kHz)
 - $\leq \pm 0.5$ dB for 1 or 2 dB / div over (RBW \leq 3 kHz)
 - Linear : $\leq \pm 3$ % of Ref Level, 10 div

2) Test Instrument

- Signal Generator : 83650B
- Attenuator : 8494, 8496
- RF Cable 1,2 : N [male] ~ N [male]
- BNC Cable : BNC [male] ~ BNC [male]

3) Setup

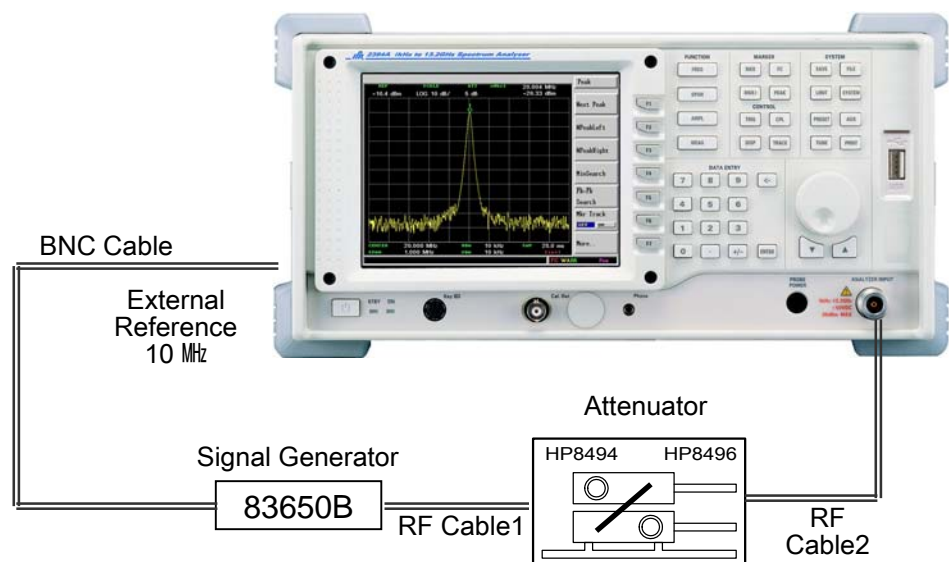

Figure 6-7. Amplitude display linearity

4) Procedure

- LOG Linearity [10 dB/div, 5 dB/div, 2 dB/div, 1 dB/div]

Step	Procedure														
1	Press <input type="text" value="PRESET"/> , <i>Preset</i> key.														
2	Press <i>Alignment Mode..</i> softkey and then <i>All Align</i> softkey.														
3	Set up the equipment as shown below : <table border="1" style="margin-left: 20px;"> <tr> <td><input type="text" value="Center frequency"/></td> <td>: 100 MHz</td> </tr> <tr> <td><input type="text" value="Reference level"/></td> <td>: 0 dBm</td> </tr> <tr> <td><input type="text" value="Span"/></td> <td>: 10 kHz</td> </tr> <tr> <td><input type="text" value="ATT"/></td> <td>: 10 dB</td> </tr> <tr> <td><input type="text" value="RBW"/></td> <td>: 1 kHz</td> </tr> <tr> <td><input type="text" value="VBW"/></td> <td>: 10 Hz</td> </tr> <tr> <td><input type="text" value="Scale"/></td> <td>: 10 dB/Div</td> </tr> </table>	<input type="text" value="Center frequency"/>	: 100 MHz	<input type="text" value="Reference level"/>	: 0 dBm	<input type="text" value="Span"/>	: 10 kHz	<input type="text" value="ATT"/>	: 10 dB	<input type="text" value="RBW"/>	: 1 kHz	<input type="text" value="VBW"/>	: 10 Hz	<input type="text" value="Scale"/>	: 10 dB/Div
<input type="text" value="Center frequency"/>	: 100 MHz														
<input type="text" value="Reference level"/>	: 0 dBm														
<input type="text" value="Span"/>	: 10 kHz														
<input type="text" value="ATT"/>	: 10 dB														
<input type="text" value="RBW"/>	: 1 kHz														
<input type="text" value="VBW"/>	: 10 Hz														
<input type="text" value="Scale"/>	: 10 dB/Div														
4	Set the Signal Generator as shown below : <table border="1" style="margin-left: 20px;"> <tr> <td><input type="text" value="Frequency"/></td> <td>: 100 MHz</td> </tr> <tr> <td><input type="text" value="Power"/></td> <td>: 0 dBm</td> </tr> </table>	<input type="text" value="Frequency"/>	: 100 MHz	<input type="text" value="Power"/>	: 0 dBm										
<input type="text" value="Frequency"/>	: 100 MHz														
<input type="text" value="Power"/>	: 0 dBm														
5	Press <input type="text" value="AMPL"/> , <i>Log</i> key and then the <i>Scale.., 10 dB/div</i> key to set the display in the Log state.														
6	Press <input type="text" value="PEAK"/> , <input type="text" value="MKR>"/> , <i>Mkr > CF</i> key and then the <i>Mkr > Ref</i> key to set the waveform peak to the center of the screen. Adjust signal generator as required to confirm that power meter measures 0 dBm.														
7	Press <input type="text" value="MKR"/> , <i>Delta</i> key and increase Attenuator in 10 dB steps [8494, 8496] reading Δ marker level.														
8	Calculate Log Linearity [10 dB/div]. Amplitude display linearity error = Attenuator value (dB) + Δ marker level														
9	Repeat Log Linearity [5 dB/div, 2 dB/div, 1 dB/div] steps 5 to 8.														

Log Display Linearity [10 dB/DIV]

Center Frequency	Test Instrument Attenuator	Δ marker Value (dB)	Error	Remark
	Setting (dB)			
100 MHz	0	0	0	Reference
	10			
	20			
	30			
	40			
	50			
	60			
	70			
3100 MHz	0	0	0	Reference
	10			
	20			
	30			
	40			
	50			
	60			
	70			
6600 MHz	0	0	0	Reference
	10			
	20			
	30			
	40			
	50			
	60			
	70			

Log Display Linearity [5 dB/DIV]

Center Frequency	Test Instrument Attenuator	Δ marker Value (dB)	Error	Remark
	Setting (dB)			
100 MHz	0	0	0	Reference
	5			
	10			
	15			
	20			
	25			
	30			
	35			
	40			
	45			
	50			
3100 MHz	0	0	0	Reference
	5			
	10			
	15			
	20			
	25			
	30			
	35			
	40			
	45			
	50			

6600 MHz	0	0	0	Reference
	5			
	10			
	15			
	20			
	25			
	30			
	35			
	40			
	45			
	50			

Log Display Linearity [2 dB/DIV]

Center Frequency	Test Instrument Attenuator	Δ marker Value (dB)	Error	Remark
	Setting (dB)			
100 MHz	0	0	0	Reference
	2			
	4			
	6			
	8			
	10			
	12			
	14			
	16			
	18			
	20			

3100 MHz	0	0	0	Reference
	2			
	4			
	6			
	8			
	10			
	12			
	14			
	16			
	18			
	20			
6600 MHz	0	0	0	Reference
	2			
	4			
	6			
	8			
	10			
	12			
	14			
	16			
	18			
	20			

Log Display Linearity [1 dB/DIV]

Center Frequency	Test Instrument Attenuator	Δ marker Value (dB)	Error	Remark
	Setting (dB)			
100 MHz	0	0	0	Reference
	1			
	2			
	3			
	4			
	5			
	6			
	7			
	8			
	9			
	10			
3100 MHz	0	0	0	Reference
	1			
	2			
	3			
	4			
	5			
	6			
	7			
	8			
	9			
	10			
6600 MHz	0	0	0	Reference
	1			
	2			
	3			
	4			
	5			
	6			
	7			
	8			
	9			
	10			

- LINEAR Linearity [Full scale]

Step	Procedure														
1	Press <input type="text" value="PRESET"/> , <i>Preset</i> key.														
2	Press <i>Alignment Mode..</i> softkey and then <i>All Align</i> softkey.														
3	Set up the equipment as shown below : <table border="1" style="margin-left: 20px;"> <tr> <td><input type="text" value="Center frequency"/></td> <td>: 100 MHz</td> </tr> <tr> <td><input type="text" value="Reference level"/></td> <td>: 0 dBm</td> </tr> <tr> <td><input type="text" value="Span"/></td> <td>: 15 kHz</td> </tr> <tr> <td><input type="text" value="ATT"/></td> <td>: 10 dB</td> </tr> <tr> <td><input type="text" value="RBW"/></td> <td>: 1 kHz</td> </tr> <tr> <td><input type="text" value="VBW"/></td> <td>: 10 Hz</td> </tr> <tr> <td><input type="text" value="Scale"/></td> <td>: 10 dB/Div</td> </tr> </table>	<input type="text" value="Center frequency"/>	: 100 MHz	<input type="text" value="Reference level"/>	: 0 dBm	<input type="text" value="Span"/>	: 15 kHz	<input type="text" value="ATT"/>	: 10 dB	<input type="text" value="RBW"/>	: 1 kHz	<input type="text" value="VBW"/>	: 10 Hz	<input type="text" value="Scale"/>	: 10 dB/Div
<input type="text" value="Center frequency"/>	: 100 MHz														
<input type="text" value="Reference level"/>	: 0 dBm														
<input type="text" value="Span"/>	: 15 kHz														
<input type="text" value="ATT"/>	: 10 dB														
<input type="text" value="RBW"/>	: 1 kHz														
<input type="text" value="VBW"/>	: 10 Hz														
<input type="text" value="Scale"/>	: 10 dB/Div														
4	Set the Signal Generator as shown below : <table border="1" style="margin-left: 20px;"> <tr> <td><input type="text" value="Frequency"/></td> <td>: 100 MHz</td> </tr> <tr> <td><input type="text" value="Power"/></td> <td>: 0 dBm</td> </tr> </table>	<input type="text" value="Frequency"/>	: 100 MHz	<input type="text" value="Power"/>	: 0 dBm										
<input type="text" value="Frequency"/>	: 100 MHz														
<input type="text" value="Power"/>	: 0 dBm														
5	Press <input type="text" value="AMPL"/> , <i>Linear</i> key and then the <input type="text" value="AMPL"/> , <i>Unit..</i> , <i>VOLTS</i> key to set the display in the linear state.														
6	Press <input type="text" value="PEAK"/> , <input type="text" value="MKR>"/> , <i>Mkr > CF</i> key to set the spectrum waveform peak to the center of the screen.														
7	By control the Signal Generator, make the output level 223 mV.														
8	Increase Attenuator [8494, 8496] by step 6 dB and reading the level.														
9	Calculate LINEAR Linearity (Full scale). Amplitude display linearity error = Attenuator value (dB) + Δ marker level.														

Linear Display Linearity (full scale)

Center Frequency	ATT Setting (dB)	Marker Value (dB)	Error	Remark
100 MHz	0	0	0	Reference
	6			
	12			
	18			
3100 MHz	0	0	0	Reference
	6			
	12			
	18			
6600 MHz	0	0	0	Reference
	6			
	12			
	18			

Frequency Response

Generally, when one or more signals with a different frequency but the same amplitude are applied to the unit, the spectrum analyzer displays the same amplitude for each signal on the screen.

1) Specification

- Frequency response : $\leq -3.0 \sim +1$ dB, 9 kHz to 5 MHz (@10dB RF attenuation)
 - $\leq \pm 1.0$ dB, 5 MHz to 2.9 GHz
 - $\leq \pm 1.5$ dB, 3.0 GHz to 6.4 GHz
 - $\leq \pm 2.2$ dB 6.4 GHz to 13.2 GHz
 - $\leq \pm 3.0$ dB 13.2 GHz to 26.5 GHz (2395A only)

2) Test Instruments

- Signal Generator : 83650B
- Power Meter : 437B
- Power Sensor : 8481A
- RF Cable 1,2,3 : N [male] ~ N [male]
- BNC Cable : BNC [male] ~ BNC [male]

3) Setup

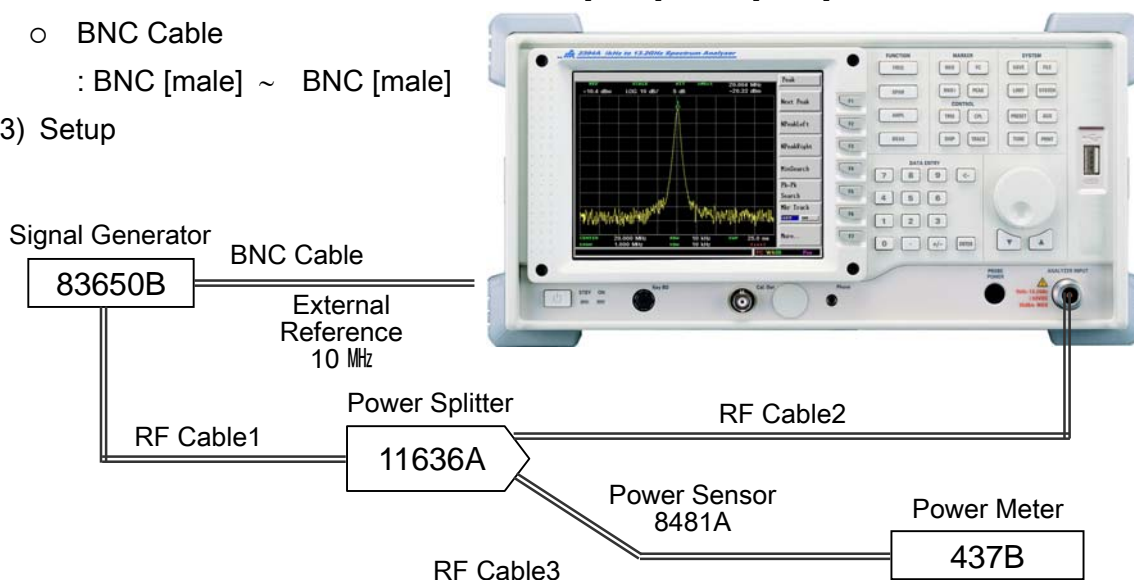

Figure 6-8. Frequency Response

4) Procedure

- Power meter calibration and measurement procedure

Step	Procedure								
1	Connect the Power Meter [437B] to Power sensor [8481A]								
2	Connect the Power sensor to Power Meter input port.								
3	Push Power REF button of Power Meter and then display value 0 dBm.								
4	If display value is not 0 dBm, turn Cal ADJ.								
5	Connect the test equipment as shown above.								
6	Adjust signal generator output level set to -4 dBm Set up the synthesized Signal Generator as shown below : <table border="1" data-bbox="368 792 798 882"> <tr> <td>Frequency</td> <td>: 10 MHz</td> </tr> <tr> <td>Power</td> <td>: -4 dBm</td> </tr> </table>	Frequency	: 10 MHz	Power	: -4 dBm				
Frequency	: 10 MHz								
Power	: -4 dBm								
7	Read the power meter display and adjust Signal Generator output level to -10 dBm.								
8	Press PRESET , <i>Preset</i> key.								
9	Press <i>Alignment Mode..</i> softkey and then <i>All Align</i> softkey.								
10	Set up the equipment as shown below : <table border="1" data-bbox="368 1137 774 1312"> <tr> <td>Center frequency</td> <td>: 10 MHz</td> </tr> <tr> <td>Reference level</td> <td>: 0 dBm</td> </tr> <tr> <td>Span</td> <td>: 10 kHz</td> </tr> <tr> <td>Couple</td> <td>: All Auto</td> </tr> </table>	Center frequency	: 10 MHz	Reference level	: 0 dBm	Span	: 10 kHz	Couple	: All Auto
Center frequency	: 10 MHz								
Reference level	: 0 dBm								
Span	: 10 kHz								
Couple	: All Auto								
11	Press PEAK , MKR> , <i>Mkr > CF</i> key to set the waveform peak to the center of the screen. Read the marker level and write to the below table.								
12	Change signal generator output frequency and adjust the Signal Generator to the level on the power meter -10 dBm.								
13	Calculate Frequency response. Error = Power meter value – display Marker peak value								

SG	Frequency	Power Meter value [dBm]	Marker peak value [dBm]	Error	Remark
83650B	10 MHz				
	50 MHz				
	300 MHz				
	700 MHz				
	1.0 GHz				
	2.0 GHz				
	3.0 GHz				
	4.0 GHz				
	6.0 GHz				
	7.0 GHz				
	8.0 GHz				
	9.0 GHz				
	10.0 GHz				
	11.0 GHz				
12.0 GHz					
13.0 GHz					
83650B (2395A Only)	14.0 GHz				
	15.0 GHz				
	16.0 GHz				
	17.0 GHz				
	18.0 GHz				
	19.0 GHz				
	20.0 GHz				
	21.0 GHz				
	22.0 GHz				
	23.0 GHz				
	25.0 GHz				
	26.0 GHz				
	26.45 GHz				

Reference Level Accuracy

Here the absolute amplitude level is tested. Confirm the level accuracy with a signal from the Signal Generator, calibrated by a standard power meter.

1) Specification

- Reference level accuracy : $\leq \pm 1.0$ dB

2) Test Instruments

- Signal Generator : 83650B
- Power Sensor : 8481A, 8481D
- Step Attenuator : 8496, 8494
- RF Cable 1,2 : N [male] ~ N [male]

3) Setup

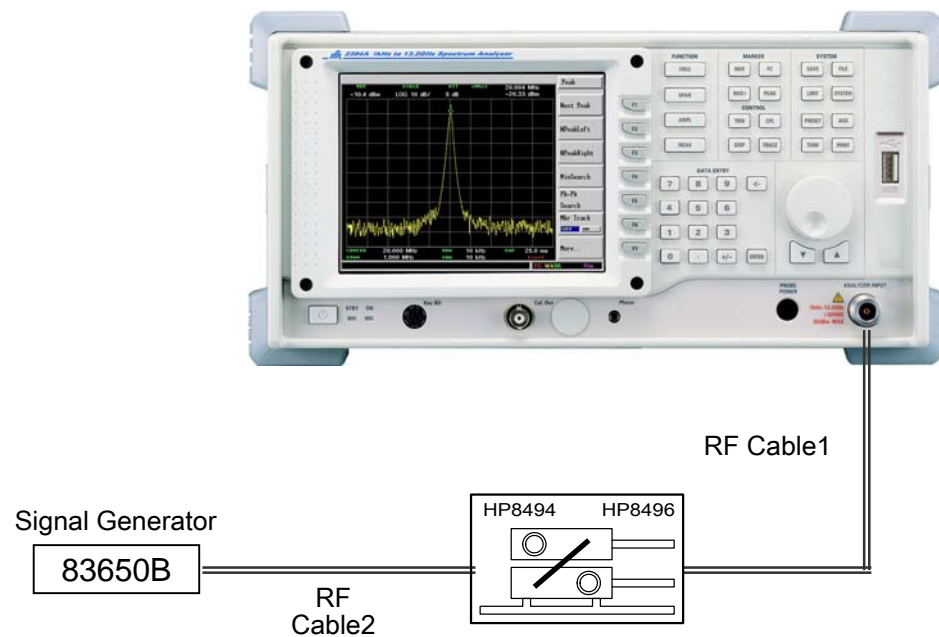

Figure 6-9. Reference level Accuracy

4) Procedure

- Power meter calibration and Reference Calibration

Step	Procedure
1	Set up the test equipment as shown above.
2	Adjust signal generator output level to -20 dBm. <div style="display: flex; align-items: center; margin-left: 20px;"> <div style="border: 1px solid black; padding: 2px 5px; margin-right: 5px;">Frequency</div> : 60 MHz </div> <div style="display: flex; align-items: center; margin-left: 20px; margin-top: 5px;"> <div style="border: 1px solid black; padding: 2px 5px; margin-right: 5px;">Power</div> : -20 dBm </div>
3	Press PRESET , <i>Preset</i> key.
4	Press <i>Alignment Mode..</i> softkey and then <i>All Align</i> softkey.
5	Set up the equipment as shown below : <div style="display: flex; align-items: center; margin-left: 20px; margin-top: 5px;"> <div style="border: 1px solid black; padding: 2px 5px; margin-right: 5px;">Center frequency</div> : 60 MHz </div> <div style="display: flex; align-items: center; margin-left: 20px; margin-top: 5px;"> <div style="border: 1px solid black; padding: 2px 5px; margin-right: 5px;">Reference level</div> : -19 dBm </div> <div style="display: flex; align-items: center; margin-left: 20px; margin-top: 5px;"> <div style="border: 1px solid black; padding: 2px 5px; margin-right: 5px;">Span</div> : 10 kHz </div> <div style="display: flex; align-items: center; margin-left: 20px; margin-top: 5px;"> <div style="border: 1px solid black; padding: 2px 5px; margin-right: 5px;">RBW</div> : 1 kHz </div> <div style="display: flex; align-items: center; margin-left: 20px; margin-top: 5px;"> <div style="border: 1px solid black; padding: 2px 5px; margin-right: 5px;">VBW</div> : 30Hz </div> <div style="display: flex; align-items: center; margin-left: 20px; margin-top: 5px;"> <div style="border: 1px solid black; padding: 2px 5px; margin-right: 5px;">ATT</div> : Auto </div>
	Adjust signal generator output level so that the Reference level in the table below is indicated (Other Ref level in table use first the 10 dB steps of the attenuator).
6	Press PEAK , MKR> , <i>Mkr > CF</i> key to set the spectrum waveform peak to the center of the screen Press <i>Mkr > Ref</i> .
7	Read the marker level.
8	Calculate Reference level accuracy : Reference level accuracy = Marker level value –Reference level.
9	Repeat the step 5 to 8 for other ref level in table.

Center Frequency [MHz]	Reference level [dBm]	Step Attenuator value (dB)	Marker level value [dBm]	Error
	-19	0		
	-29	10		
	-39	20		
	-49	30		
	-59	40		
	-69	50		
	-79	60		
	-89	70		
3100	-19	0		
	-29	10		
	-39	20		
	-49	30		
	-59	40		
	-69	50		
	-79	60		
	-89	70		
6600	-19	0		
	-29	10		
	-39	20		
	-49	30		
	-59	40		
	-69	50		
	-79	60		
	-89	70		
15000 (2395A Only)	-19	0		
	-29	10		
	-39	20		
	-49	30		
	-59	40		
	-69	50		

	-79	60		
	-89	70		

Average Noise Level

The internal noise of the spectrum analyzer is measured with this test.

1) Specification

- Average noise level : [RBW : 300 Hz , VBW : 10 Hz]
 - ≤ -105 dBm, 50 kHz to 100kHz
 - ≤ -110 dBm, 100kHz to 2.8GHz
 - ≤ -105 dBm, 2.8GHz to 3.0GHz
 - ≤ -115 dBm, 3.0GHz to 13.2GHz (2394A)
 - ≤ -110 dBm, 3.0GHz to 13.2GHz (2395A)
 - ≤ -100 dBm, 13.2GHz to 26.5GHz (2395A)

2) Test Instruments

- 50 ohm termination : 909F

3) Set up



50ohm
Termination
HP909F



Figure 6-10. Average Noise level

4) Procedure

Step	Procedure
1	Press PRESET , <i>Preset</i> key.
2	Press <i>Alignment Mode..</i> softkey and then <i>All Align</i> softkey.
3	Set up the equipment as shown below : Center frequency : 2.5 GHz Span : 10 kHz Reference level : -50dBm ATT : 0dB RBW : 300 Hz VBW : 10 Hz Detector mode : Average
4	Terminate the RF Input with a 50 Ω terminator.
5	Press PEAK , MKR> , <i>Mkr > CF</i> key to set the spectrum waveform peak to the center of the screen.
6	Change the equipment as show below.

- 7 Press TRACE, *More..*, *Average..*, *Average [ON]*, *Count [16]* key.
- 8 Press TRACE, *More..*, *Average..*, *Continuous* key to start the averaging and wait until the 16 sweeps has been completed.
- 9 Press PEAK key to execute peak search. At this point read the level value at the marker.
- 10 With changing the center frequency, repeat the step 7 to 9.

Center Frequency	Span	Average noise level	Remark
50 kHz	10 kHz		
500 kHz			
2.5 GHz			
2.95 GHz			
3.0 GHz			
3.6 GHz			
4.0 GHz			
4.3 GHz			
5.0 GHz			
6.0 GHz			
6.35 GHz			
6.4 GHz			
7.8 GHz			
9.6 GHz			
11.0 GHz			
13.0 GHz			
(2395A only)			
15.0 GHz			
17.0 GHz			
19.0 GHz			
23.0 GHz			
25.0 GHz			
26.45 GHz			

Second Harmonic Distortion

The main point of the test is to apply a signal with harmonic distortion that is lower than the equipment internal harmonic distortion [at least 20dB below] to the equipment and measure the level difference between the fundamental signal and the second harmonic.

A low-distortion signal source can be obtained by applying a signal to the equipment after passing the signal through a low-pass filter (LPF).

1) Specification

- Second harmonic distortion : ≤ -65 dBc, (-30 dBm input, 0 dB attenuation)

2) Test Instruments

- Signal Generator : 83650B
- RF Cable 1,2 : N [male] ~ N [male]
- LPF : With attenuation of 70 dB or more at twice the fundamental frequencies

3) Setup

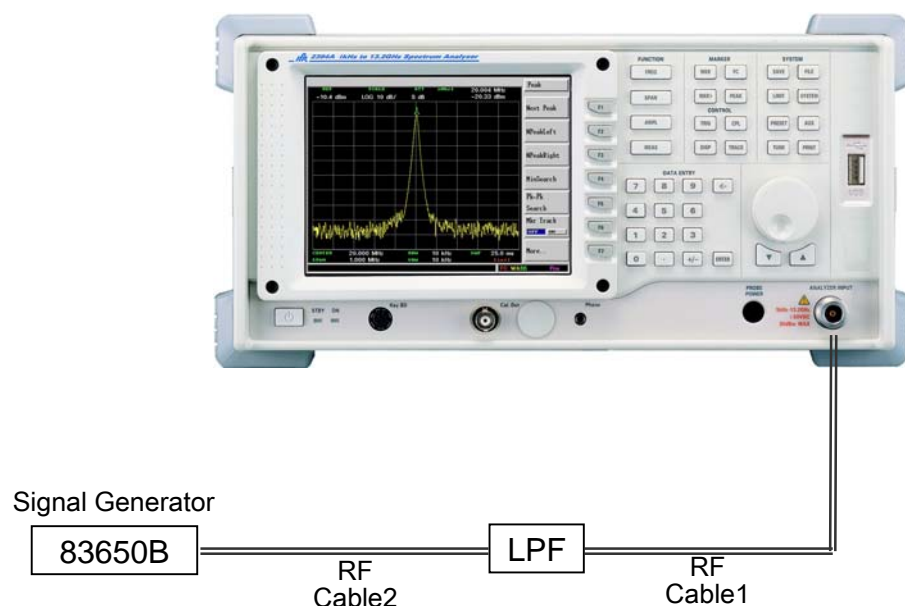

Figure 6-11. Second Harmonic Distortion

4) Procedure

Step	Procedure														
1	Press PRESET , <i>Preset</i> key.														
2	Press <i>Alignment Mode..</i> softkey and then <i>All Align</i> softkey.														
3	Set up the equipment as shown below : <table border="1" style="margin-left: 20px;"> <tr><td>Center frequency</td><td>: 95 MHz</td></tr> <tr><td>Span</td><td>: 50 kHz</td></tr> <tr><td>Reference level</td><td>: -30 dBm</td></tr> <tr><td>ATT</td><td>: 0 dB</td></tr> <tr><td>RBW</td><td>: 300 Hz</td></tr> <tr><td>VBW</td><td>: 30 Hz</td></tr> <tr><td>Sweep time</td><td>: Auto</td></tr> </table>	Center frequency	: 95 MHz	Span	: 50 kHz	Reference level	: -30 dBm	ATT	: 0 dB	RBW	: 300 Hz	VBW	: 30 Hz	Sweep time	: Auto
Center frequency	: 95 MHz														
Span	: 50 kHz														
Reference level	: -30 dBm														
ATT	: 0 dB														
RBW	: 300 Hz														
VBW	: 30 Hz														
Sweep time	: Auto														
4	Set the Signal Generator as shown below : <table border="1" style="margin-left: 20px;"> <tr><td>Frequency</td><td>: 95 MHz</td></tr> <tr><td>Power</td><td>: -30 dBm</td></tr> </table>	Frequency	: 95 MHz	Power	: -30 dBm										
Frequency	: 95 MHz														
Power	: -30 dBm														
5	Adjust the Signal Generator level that the signal measured is -30 dBm on the equipment.														
6	Set the Center Frequency to twice the fundamental frequency to display the second harmonic on the screen.														
7	Press PEAK , MKR> , <i>Mkr > CF</i> key and calculate the difference from -30dBm. Write to table.														
8	According to table adjust the frequency and LPF, repeat the step 3 to 7.														

Signal Generator		Second harmonic		
Output power	Frequency	Marker level	dBc	Frequency
-30dBm	95 MHz			190 MHz
	245 MHz			490 MHz
	495 MHz			990 MHz
	995 MHz			1990 MHz

Input Attenuator Switching Error

This test measures the switching error when the amount of attenuation in the RF input section is switched.

1) Specification

- Input Attenuator switching error : $\pm 0.5\text{dB}$ by steps,
 $\pm 1\text{ dB}$ full steps

2) Test Instruments

- Signal Generator : 83650B
- RF Cable : N [male] ~ N [male]
- BNC Cable : BNC [male] ~ BNC [male]

3) Setup

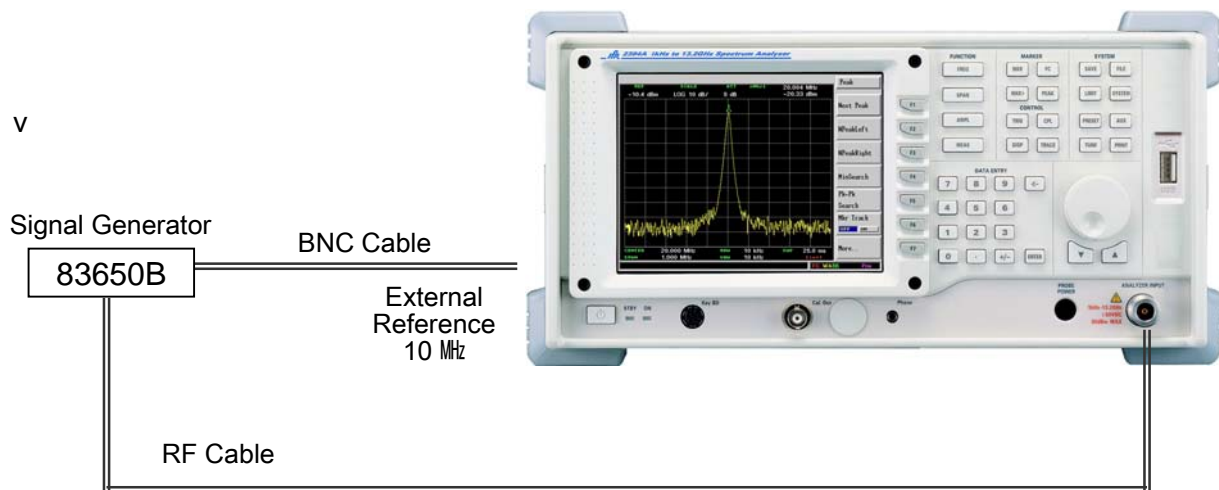

Figure 6-12. Input Attenuator Switching Error

4) Procedure

- Power meter calibration and signal generator calibration

Step	Procedure																
1	Press PRESET , <i>Preset</i> key.																
2	Press <i>Alignment Mode..</i> softkey and then <i>All Align</i> softkey.																
3	Set up the equipment as shown below :																
	<table border="1"> <tr> <td>Center frequency</td> <td>: 100 MHz</td> </tr> <tr> <td>Span</td> <td>: 500 kHz</td> </tr> <tr> <td>Reference level</td> <td>: -10 dBm</td> </tr> <tr> <td>ATT</td> <td>: 0 dB</td> </tr> <tr> <td>RBW</td> <td>: Auto</td> </tr> <tr> <td>VBW</td> <td>: Auto</td> </tr> <tr> <td>Sweep time</td> <td>: Auto</td> </tr> <tr> <td>Average</td> <td>: ON</td> </tr> </table>	Center frequency	: 100 MHz	Span	: 500 kHz	Reference level	: -10 dBm	ATT	: 0 dB	RBW	: Auto	VBW	: Auto	Sweep time	: Auto	Average	: ON
Center frequency	: 100 MHz																
Span	: 500 kHz																
Reference level	: -10 dBm																
ATT	: 0 dB																
RBW	: Auto																
VBW	: Auto																
Sweep time	: Auto																
Average	: ON																
4	Set the signal generator 83650B as show below :																
	<table border="1"> <tr> <td>Frequency</td> <td>: 100 MHz</td> </tr> <tr> <td>Power</td> <td>: -20 dBm</td> </tr> </table>	Frequency	: 100 MHz	Power	: -20 dBm												
Frequency	: 100 MHz																
Power	: -20 dBm																
5	Press PEAK , MKR> , <i>Mkr > CF</i> and <i>Mkr > Ref</i> key to set the spectrum waveform peak to the center and top of the screen.																
6	Press MKR , <i>Delta</i> key, check the marker level is 0.																
7	Press AMPL , <i>Atten [MNL], 10 dB</i> key, set attenuator to 10 dB, read the delta marker level and write down on table.																
8	Press MKR , <i>OFF</i> .																
9	Repeat the step 5 to 8 for other value in table. In each turn set the input attenuator to measure in 7 step.																
10	When end the measurement, Sum the each peak delta level with same sign. And then the result compares with spec in the table.																

Center Frequency [MHz]	Input Attenuator		Delta Marker level	Spec
	Before change ATT	After change ATT		
100	0 dB	5 dB		±0.5dB
	5 dB	10 dB		
	10 dB	15 dB		
	15 dB	20 dB		
	20 dB	25 dB		
	25 dB	30 dB		
	30 dB	35 dB		
	35 dB	40 dB		
	40 dB	45 dB		
	45 dB	50 dB		
	50 dB	55 dB		

6600	0 dB	5 dB		±0.5dB
	5 dB	10 dB		
	10 dB	15 dB		
	15 dB	20 dB		
	20 dB	25 dB		
	25 dB	30 dB		
	30 dB	35 dB		
	35 dB	40 dB		
	40 dB	45 dB		
	45 dB	50 dB		
	50 dB	55 dB		

Residual FM

Measure the purity of frequency.

- 1) Specification : ≤ 100 Hz_{P-P} in 200 ms, RBW 1 kHz, VBW 1 kHz
- 2) Test Instruments
 - Signal Generator : 83650B
 - RF Cable : N [male] ~ N [male]
- 3) Setup

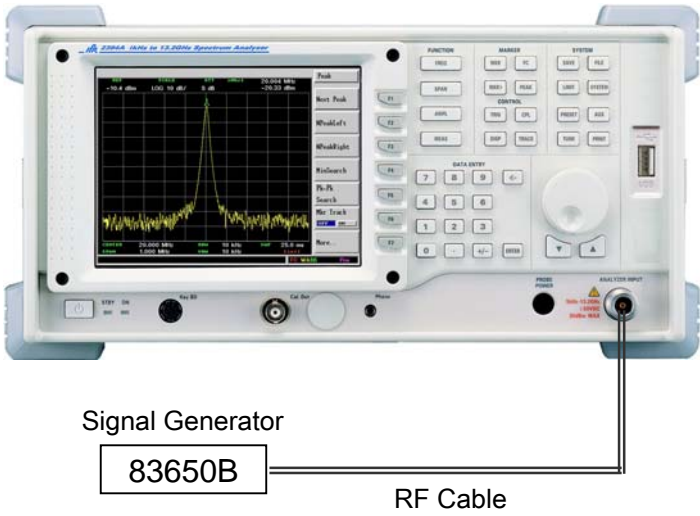

Figure 6-13. Residual FM

4) Procedure

Step	Procedure														
1	Press <input type="text" value="PRESET"/> , <i>Preset</i> key.														
2	Press <i>Alignment Mode..</i> softkey and then <i>All Align</i> softkey.														
3	Set up the equipment as shown below : <table><tbody><tr><td><input type="text" value="Center frequency"/></td><td>: 3 GHz</td></tr><tr><td><input type="text" value="Reference level"/></td><td>: -20 dBm</td></tr><tr><td><input type="text" value="Span"/></td><td>: 10 kHz</td></tr><tr><td><input type="text" value="RBW"/></td><td>: 1 kHz</td></tr><tr><td><input type="text" value="VBW"/></td><td>: 1 kHz</td></tr><tr><td><input type="text" value="Sweep time"/></td><td>: 50 ms</td></tr><tr><td><input type="text" value="Log Scale"/></td><td>: 1 dB/Div</td></tr></tbody></table>	<input type="text" value="Center frequency"/>	: 3 GHz	<input type="text" value="Reference level"/>	: -20 dBm	<input type="text" value="Span"/>	: 10 kHz	<input type="text" value="RBW"/>	: 1 kHz	<input type="text" value="VBW"/>	: 1 kHz	<input type="text" value="Sweep time"/>	: 50 ms	<input type="text" value="Log Scale"/>	: 1 dB/Div
<input type="text" value="Center frequency"/>	: 3 GHz														
<input type="text" value="Reference level"/>	: -20 dBm														
<input type="text" value="Span"/>	: 10 kHz														
<input type="text" value="RBW"/>	: 1 kHz														
<input type="text" value="VBW"/>	: 1 kHz														
<input type="text" value="Sweep time"/>	: 50 ms														
<input type="text" value="Log Scale"/>	: 1 dB/Div														
4	Set the signal generator 83650B as show below : <table><tbody><tr><td><input type="text" value="Frequency"/></td><td>: 3 GHz</td></tr><tr><td><input type="text" value="Power"/></td><td>: -20 dBm</td></tr></tbody></table>	<input type="text" value="Frequency"/>	: 3 GHz	<input type="text" value="Power"/>	: -20 dBm										
<input type="text" value="Frequency"/>	: 3 GHz														
<input type="text" value="Power"/>	: -20 dBm														
5	Press <input type="text" value="MKR"/> , <i>Normal</i> and Press <input type="text" value="SPAN"/> , <i>Zero Span</i> .														
6	Change frequency of signal generator and Press <input type="text" value="MKR"/> , <i>Delta</i> key when the equipment maker level is -25 dBm.														
7	Record frequency of signal generator(A).														
8	Go on Change frequency when the equipment delta marker level is -2 dBm.														
9	Record frequency of signal generator(B).														
10	Press <input type="text" value="Trig"/> , <i>Single</i> key and check peak to peak value(C).														

$$\text{Residual FM} = (B - A) \times C / 2$$

3rd Order Intermodulation

Two Signal Generator provide the signals required for measuring third order intermodulation. It is difficult when the input level is -30dBm because the intermodulation signal is very close in level to the noise.

- 1) Specification : $\leq -70\text{ dBc}$, 100 MHz to 13.2 GHz (-30 dBm input, 0 dB att.)
 $\leq -70\text{ dBc}$, 13.2 GHz to 26.5 GHz (-30 dBm input, 0 dB att.)(2395A only)
 $\leq -65\text{ dBc}$, 10 MHz to 100 MHz (-30 dBm input, 0 dB att.)

2) Test Instruments

- Signal Generator 1,2 : 83650B, 83620A
- Step Attenuator : 8494B, 8496B
- Power Meter : 437B
- Power Sensor : 8481A
- Power Splitter : 11636A
- RF Cable 1,2,3,4 : N [male] ~ N [male]
- BNC Cable 1,2 : BNC [male] ~ BNC [male]
- Adapter : T-BNC [female]

3) Setup

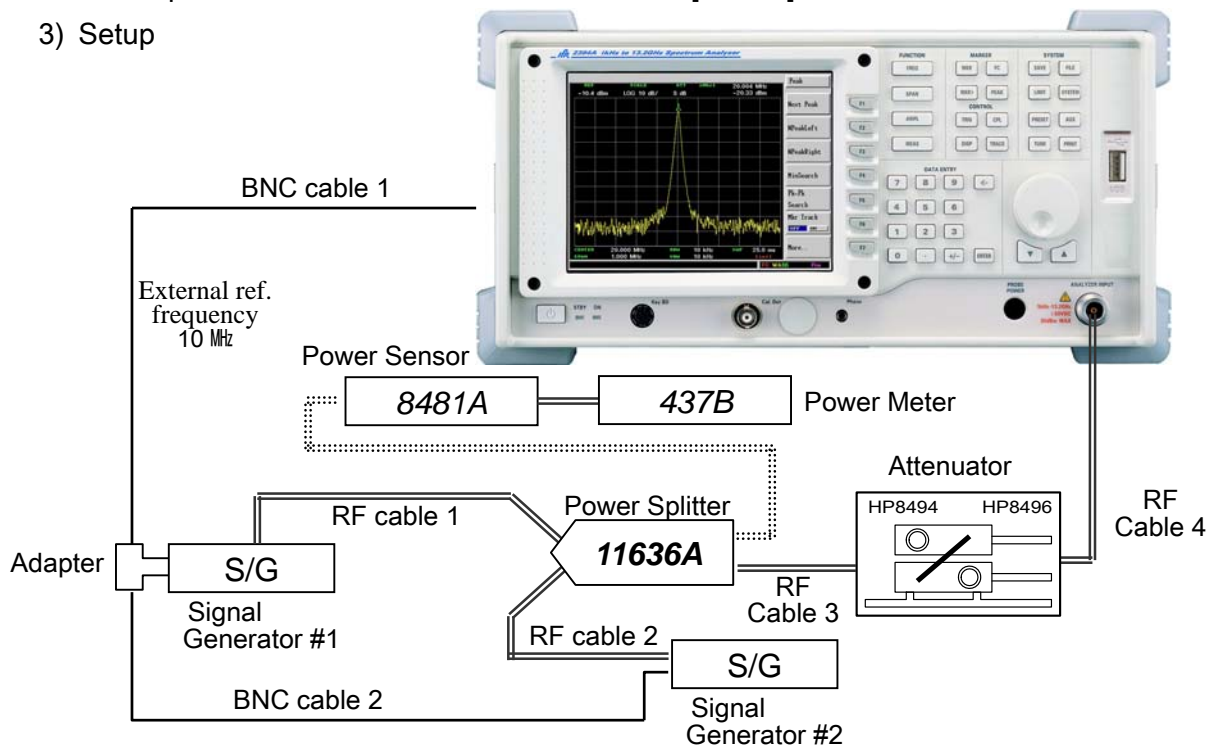

Figure 6-14. 3rd Order intermodulation

4) Procedure

- Power meter calibration

Step	Procedure
1	Set up synthesized signal generators as shown on previous page. Signal Generator 1 <div style="display: flex; align-items: center; margin-bottom: 5px;"> <div style="border: 1px solid black; padding: 2px 5px; margin-right: 5px;">Frequency</div> <div style="margin-left: 10px;">: 10 MHz</div> </div> <div style="display: flex; align-items: center; margin-bottom: 5px;"> <div style="border: 1px solid black; padding: 2px 5px; margin-right: 5px;">Power</div> <div style="margin-left: 10px;">: -24 dBm</div> </div> Signal Generator 2 <div style="display: flex; align-items: center; margin-bottom: 5px;"> <div style="border: 1px solid black; padding: 2px 5px; margin-right: 5px;">Frequency</div> <div style="margin-left: 10px;">: 10.1 MHz</div> </div> <div style="display: flex; align-items: center; margin-bottom: 5px;"> <div style="border: 1px solid black; padding: 2px 5px; margin-right: 5px;">Power</div> <div style="margin-left: 10px;">: -24 dBm</div> </div>

Step	Procedure
2	Set up the equipment as shown below : <div style="display: flex; align-items: center; margin-bottom: 5px;"> <div style="border: 1px solid black; padding: 2px 5px; margin-right: 5px;">Center frequency</div> <div style="margin-left: 10px;">: 10 MHz</div> </div> <div style="display: flex; align-items: center; margin-bottom: 5px;"> <div style="border: 1px solid black; padding: 2px 5px; margin-right: 5px;">Reference level</div> <div style="margin-left: 10px;">: -30 dBm</div> </div> <div style="display: flex; align-items: center; margin-bottom: 5px;"> <div style="border: 1px solid black; padding: 2px 5px; margin-right: 5px;">Span</div> <div style="margin-left: 10px;">: 1 MHz</div> </div> <div style="display: flex; align-items: center; margin-bottom: 5px;"> <div style="border: 1px solid black; padding: 2px 5px; margin-right: 5px;">ATT</div> <div style="margin-left: 10px;">: Auto</div> </div> <div style="display: flex; align-items: center; margin-bottom: 5px;"> <div style="border: 1px solid black; padding: 2px 5px; margin-right: 5px;">RBW</div> <div style="margin-left: 10px;">: 3 kHz</div> </div> <div style="display: flex; align-items: center; margin-bottom: 5px;"> <div style="border: 1px solid black; padding: 2px 5px; margin-right: 5px;">VBW</div> <div style="margin-left: 10px;">: 100 Hz</div> </div> <div style="display: flex; align-items: center; margin-bottom: 5px;"> <div style="border: 1px solid black; padding: 2px 5px; margin-right: 5px;">Sweep Time</div> <div style="margin-left: 10px;">: Auto</div> </div> <div style="display: flex; align-items: center; margin-bottom: 5px;"> <div style="border: 1px solid black; padding: 2px 5px; margin-right: 5px;">10 MHz Ref.</div> <div style="margin-left: 10px;">: EXT</div> </div>
3	Adjust signal generator 1 level so that power meter reads -30 dBm.
4	Press PEAK key to set the normal marker to one at the two signals at -30 dBm.
5	Press MKR , <i>Delta</i> key.
6	Move normal marker to peak of the intermodulation product signal(left side of signal generator 1 (10 MHz – 0.1Hz) or right side of signal generator 2 (10.1 MHz + 0.1Hz)). Read level difference and write in the following table.
7	Repeat the step 3 to 6 for other frequency in the following table.

Signal Generator(-30 dBm)		3 rd order Intermodulation distortion	
#1 (MHz)	#2 (MHz)	Δ maker (dBc)	Specification(dBc)
10 100	10.1 100.1		-65
700 1000 3000 6000 7000 9000	700.1 1000.1 3000.1 6000.1 7000.1 9000.1		-70
14000 26000	14000.1 26000.1		-70 (2395A only)

Spurious Response

This test measures spurious frequency levels in the equipment.

The RF Input is terminated and 0 dB Input attenuation is selected.

- 1) Specification : ≤ -85 dBm (Input terminated, 0 dB attenuation)
- 2) Test Instruments
 - 50 ohm Termination : 909F
- 3) Setup



50ohm
Termination
909F



Figure 6-15. Residual Response

4) Procedure

Step	Procedure																
1	Press PRESET , <i>Preset</i> key.																
2	Press <i>Alignment Mode..</i> softkey and then <i>All Align</i> softkey.																
3	Set up the equipment as shown below : <table border="1" style="margin-left: 20px;"> <tbody> <tr> <td>Center frequency</td> <td>: 10 MHz</td> </tr> <tr> <td>Span</td> <td>: 300 kHz</td> </tr> <tr> <td>Reference level</td> <td>: -40 dBm</td> </tr> <tr> <td>ATT</td> <td>: 0 dB</td> </tr> <tr> <td>RBW</td> <td>: 1 kHz</td> </tr> <tr> <td>VBW</td> <td>: Auto</td> </tr> <tr> <td>Sweep Time</td> <td>: Auto</td> </tr> <tr> <td>Detector Mode</td> <td>: Pos Peak</td> </tr> </tbody> </table>	Center frequency	: 10 MHz	Span	: 300 kHz	Reference level	: -40 dBm	ATT	: 0 dB	RBW	: 1 kHz	VBW	: Auto	Sweep Time	: Auto	Detector Mode	: Pos Peak
Center frequency	: 10 MHz																
Span	: 300 kHz																
Reference level	: -40 dBm																
ATT	: 0 dB																
RBW	: 1 kHz																
VBW	: Auto																
Sweep Time	: Auto																
Detector Mode	: Pos Peak																
4	Press DISP , <i>Disp Line [ON]</i> , <i>Disp Line</i> key and rotate knob to -85 dBm.																
5	Press TRIG , <i>Single</i> key. Wait for completion of the sweep. Any residual responses must be below the display line.																
6	Press PEAK key and record marker amplitude.																
7	Set center frequency step to 10 MHz using FREQ , <i>CF Step [MNL]</i> , <i>CF Step</i> and change the Center frequency.																
8	Follow the proceeding step 5 to 7.																

Frequency	Marker Amplitude [dBm]	Equipment Specification [dBm]
10 MHz		< -85
⋮		
13.2 GHz		
⋮		< -85 (2395A only)
26.5 GHz		

Input VSWR

This test verifies the Input VSWR of the equipment.

Specification

Band 0 : $\leq 1.5 : 1$ @ 10 dB ATT

Band 1,2 : $\leq 1.4 : 1$

1) Test Instruments

- Network Analyzer 1 : Agilent 8720D
 ※ Frequency Range : 50 MHz ~ 20 GHz
- Network Analyzer 2 : Agilent 8751A
 ※ Frequency Range : 5 Hz ~ 500 MHz
 (S-parameter [8751A] : 100 kHz ~ 500 MHz)
- Calibration Cable : 85131-60012 [3.5mm flexible]
 85131-60013 [3.5mm flexible]
 N [male] ~ N [male]
- Calibration Kit : 85052B [3.5mm]
 85032B [Type N]
- Adapter : SMA [female] ~ N [male]

2) Setup

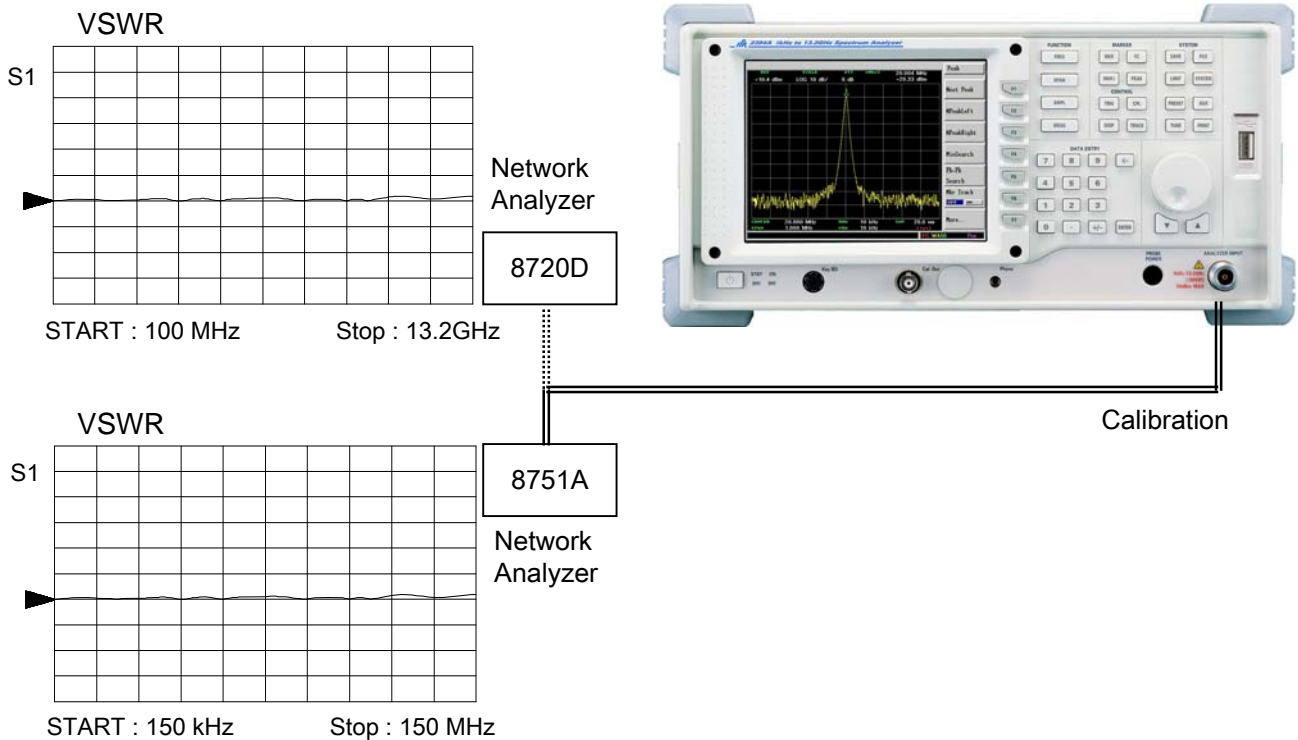

Figure 6-17. Input VSWR

3) Procedure

Step	Procedure
1	Press <input type="text" value="PRESET"/> , <i>Preset</i> .
2	Press <i>Alignment Mode..</i> and <i>All Align</i> softkey.
3	Set up the equipment as shown below : <input type="text" value="Center frequency"/> : 100 MHz <input type="text" value="ATT"/> : 10 dB
4	Set up the Network Analyzer(8751A) as shown below : <input type="text" value="Start frequency"/> : 150 kHz <input type="text" value="Stop frequency"/> : 150 MHz <input type="text" value="Output Level"/> : -10 dBm
5	Connect cable to Network Analyzer and calibrate following each equipment calibration procedure.
6	Connect the cable in Network Analyzer to spectrum analyzer and measure the VSWR. Compare with specification.
7	Output Power off the Network Analyzer and disconnect the cable.
8	Set up the Network Analyzer(8720D) as shown below : <input type="text" value="Start frequency"/> : 100 MHz <input type="text" value="Stop frequency"/> : 3.0 GHz <input type="text" value="Output Level"/> : -10 dBm
9	Repeat the step 5 to 7.

Frequency range		Measurement(Max)	Specification
Band0	150 kHz ~ 150 MHz		≤ 1.5 : 1
	100 MHz ~ 3.0 GHz		
Band1	2.9 GHz ~ 6.4 GHz		≤ 1.4 : 1
Band2	6.3 GHz ~ 13.2 GHz		
Band3 (2395A)	13.2 GHz ~ 26.5 GHz		

SECTION 7 STORAGE AND TRANSPORTATION

This section describes the long-term storage, repacking and transportation of the equipment as well as the regular care procedures and the timing.

TABLE OF CONTENTS

CLEANING	7-3
STORAGE PRECAUTIONS	7-4
Precautions Before Storage	7-4
Recommended Storage Precautions	7-4
REPACKING AND TRANSPORTATION	7-5
Repacking	7-5
Transportation	7-5
SERVICE	7-6

<BLANK>

SECTION 7 STORAGE AND TRANSPORTATION

CLEANING

Always turn the equipment POWER switch OFF and disconnect the power plug from the AC power inlet before cleaning the cabinet.

To clean the external cabinet :

- Use a soft, dry cloth for wiping off.
- Use a cloth moistened with diluted neural cleaning liquid if the instrument is very dirty of before long term storage.

After insuring that the cabinet has been thoroughly dried, use a soft, dry cloth for wiping off.

- If loose screw is found, tighten them with the appropriate tools.

CAUTION 

Never use benzene, thinner, or alcohol to clean the external cabinet : it may damage the coating, or cause deformation or discoloration.

STORAGE PRECAUTIONS

This paragraph describes the precautions to take for long term storage of the equipment.

Precautions before storage

1. Before storage, wipe dust, finger marks, and other dirt off of the equipment.
2. Close the front cover.
3. Avoid storing the equipment where :
 - 1) It may be exposed to direct sunlight or high dust levels.
 - 2) It may be exposed to active gases.
 - 3) It may be exposed to extreme temperatures ($> 50^{\circ}\text{C}$) or high humidity ($> 90\%$).

Recommended storage precautions

The recommended storage conditions are as follows :

- Temperature..... 0 to 50°C
- Humidity 10% to 60%

REPACKING AND TRANSPORTATION

The following precautions should be take if the equipment must be returned to Aeroflex for servicing.

Repacking

Use the original packing materials. If the equipment is packed in other materials, observe the following packing procedure :

- 1) Wrap the equipment in plastic sheet or similar material.
- 2) Use a corrugated paper, wooden box, or aluminum case, which allows shock-absorbent material to be inserted on all sides of the equipment.
- 3) Secure the container with packing straps, adhesive tape or bands.

Transportation

Do not subject the equipment to severe vibration during transport. It should be transported under the recommended storage conditions.

SERVICE

If the equipment is damaged or does not operate as specified, contact your nearest Aeroflex dealer or business office (refer to the rear of this manual) for repair. When you request repair, provide the following information :

- 1) Model number and serial number on rear panel.
- 2) Fault description : Symptom, operation procedure before fault (include peripheral or equipment and plot of connection circuit), circumstance (temperature, humidity, time, date, place), guess of yours etc.
- 3) Name of a personnel-in-charge and address for contact when fault confirmed or at completion of repair.

Appendix A

Measurement Guide

TABLE OF CONTENTS

1. INSTRUMENT OVERVIEW	1-1
Front-Panel Features	1-1
Rear-Panel Features	1-5
Display Annotation	1-7
2. MAKING BASIC MEASUREMENTS	2-1
What is in This Chapter	2-1
Comparing Signals	2-2
Example : Delta marker function	2-2
Resolving Signals of Equal Amplitude	2-4
Example : Selection RBW	2-5
Resolving Small Signals Hidden by Large Signals	2-7
Example : Selection RBW	2-8
Making Better Frequency Measurements	2-10
Example : Marker counter function	2-10
Decreasing the Frequency Span Around the Signal	2-12
Example : Mkr Track function	2-12
Tracking Drifting Signals	2-14
Example 1 : Mkr Track function	2-14
Example 2 : Max Hold function	2-17
Measuring Low Level Signals	2-19
Example 1 : Set input attenuation	2-20
Example 2 : Selection RBW	2-22
Example 3 : Selection VBW	2-24
Example 4 : Video average function	2-26

Identifying Distortion Products -----	2-29
Distortion from the Analyzer -----	2-29
Example : Delta marker function -----	2-29
Third-Order Intermodulation Distortion -----	2-31
Example : Delta marker function -----	2-31
Marking Noise Measurements -----	2-33
Example 1 : MKR Noise function -----	2-33
Example 2 : Video filtering/Average -----	2-35
Example 3 : Channel power measurement -----	2-36
Demodulating AM Signals -----	2-38
Example : AM Demod. function -----	2-39
Demodulating FM Signals -----	2-42
Example 1 : Delta marker function-----	2-42
Example 2 : FM Demod. function -----	2-44

1. INSTRUMENT OVERVIEW

- Front Panel
- Rear Panel
- Screen Annotation

In this manual call the key in front panel as hard key and be expressed box of letter.

Call the soft key on the menu in screen and be expressed italic.

Ex.] FREQ *Center*

Front-Panel Features

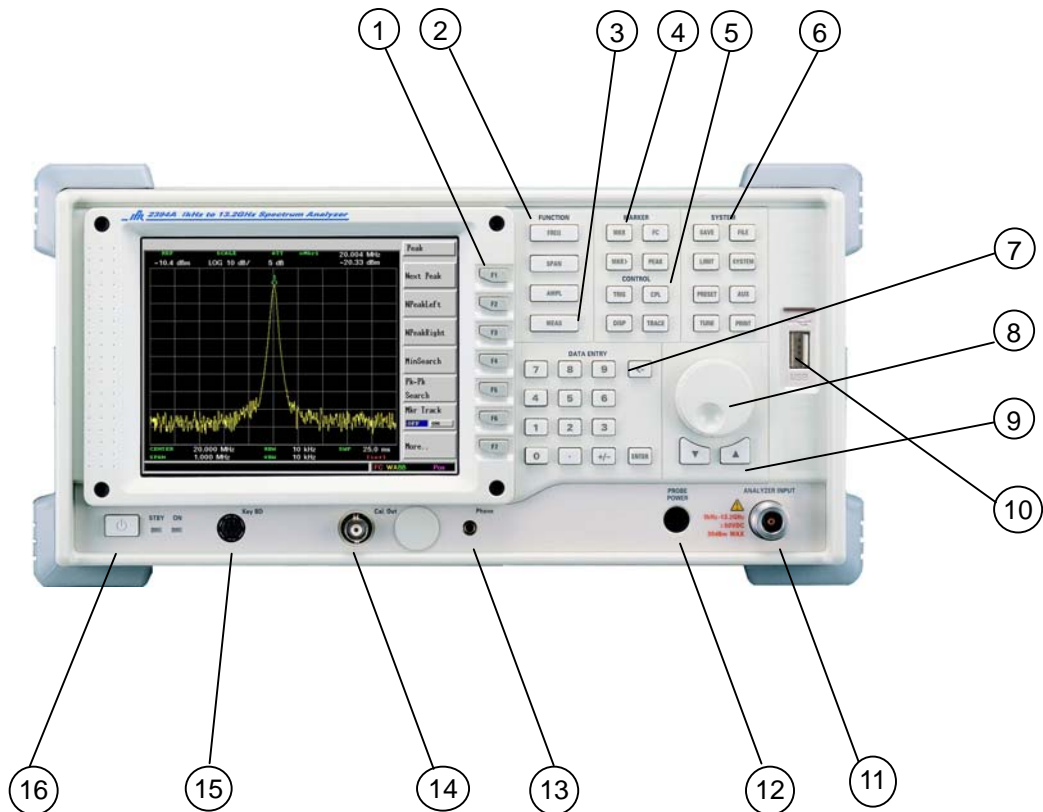

Figure 1-1. Front-Panel Feature Overview

- ① **Soft Menu keys** are the labeled keys (F1 to F7) on the side of screen. The soft menu key functions are annotated on the screen each side of the menu keys one to one. Most of the labeled keys on the analyzer front panel (also called hard keys) access menus of keys having related functions.

- ② **FUNCTION** hard keys activate the primary analyzer functions and access menus of related functions.

- ③ **MEAS** hard key accesses a menu of keys that automate some common analyzer measurements. In software option, MEAS menu performed the each unique operations.

- ④ **MARKER** hard keys conduct control the markers, read out frequencies and amplitudes along the analyzer trace, automatically locate the signals of highest amplitude, and access functions like Marker Noise and etc.

CONTROL hard keys functions access menus that allow you to adjust the resolution

bandwidth, adjust the sweep time, set trigger functions, control the instrument display,

⑤ and select a kind of trace. They also set other analyzer parameters needed for making measurements.

⑥ **SYSTEM** functions affect the state of the entire spectrum analyzer. Various setup is accessed with the **SYSTEM** key.

The **Save** key immediately executes the Save function defined next **File** key.

The **File** key displays file directory and allows you to copy and load traces, states, limit-line tables, and amplitude correction factors to or from analyzer memory or the floppy disk drive. And file delete, copy, rename, select disk drive, select file type, sort directory etc.

The **LIMIT** key configures the upper or lower limit line to indicate that the signal level is pass or fail.

The **Preset** key resets the analyzer to a known state and can execute various alignment routines.

The **AUX** key sets the auxiliary functions, such as AM/FM demodulation, audio and squelch level.

The **TUNE** key performs seeking peak signal and tuning the parameters.

The **PRINT** key immediately sends hardcopy data to the printer.

The print setup can be done in **SYSTEM** *Printer Config.* which allow you to configure printer types.

⑦ **DATA ENTRY** is include numeric key, back space(<-), sign(+/-), ENTER, scroll knob and step keys. This used for entering the number or adjust value or moving marker or moving cursor etc.

Number Keys include numeric key, back space(<-), sign(+/-) and ENTER key. These keys allow you to change the numeric value of an active function. You may include a decimal point in the number portion. If not, the decimal point is placed at the end of the number. Ending the input by press ENTER key or press the soft key annotated in menu area as unit for special value. Example in frequency case the unit soft key is assigned as GHz, MHz, kHz, Hz and amplitude case dBm, dBmV, dBuV etc.

- ⑧ The **Scroll Knob** allows continuous change of functions such as center frequency, reference level, and marker position. It also changes the values of many functions that change sequentially. Clockwise rotation of the knob increases values and otherwise decrease. For continuous changes, the extent of alteration is determined by the size of the measurement range; the speed at which the knob is turned affects the rate at which the values are changed.

- ⑨ The **Step Keys** (▼ ▲) allow discrete increases or decreases of the active function value.
- The step size depends upon the analyzer measurement range or on a preset amount.
- Each press results in a single step change. For those parameters with fixed values, the next value in a sequence is selected each time a step key is pressed. Changes are predictable and can be set for some functions. Out-of-range values or out-of-sequence values will not occur using these keys.

NOTE :

If an entry from the numeric keypad does not coincide with an allowed function value (for example, that of a 12 MHz resolution bandwidth), the analyzer defaults to the nearest allowable value as 3 MHz.

- ⑩ **USB Port** : On the right side of the front panel is for data access media.
- ⑪ **RF INPUT 50Ω** : the signal input for the analyzer.
- ⑫ **PROBE POWER** : HP85024A(High Frequency Probe) or compatible probe can use.
- ⑬ **Phone** : The earphone connector provides a connection for a mono earphone jack which bypasses the internal speaker.

⑭ **Cal. OUT** : The calibration signal output; 20MHz, -20dBm.

⑮ **Key BD** : The **EXT KEYBOARD** connector is a 6-pin mini-DIN connector for future use with PC keyboards. (Only for system calibration and maintenance)

⑯ **STBY/ON** : Turns the analyzer on or off. The STBY LED is on when the power switch (line switch) is on in the rear panel. In standby state the analyzer is turned on by pressing momentarily the STBY/ON key. An instrument alignment is performed every time the analyzer is turned on. After turning on the analyzer, allow 15 minutes of warm-up time to ensure the analyzer will meet all specification. The analyzer is turned off and returned to the standby state by pressing the STBY/ON key for about one second.

NOTE :

The instrument continues to draw power even if the line power switch is in standby. The detachable power cord is the instrument-disconnecting device. It disconnects the main circuits from the main supply before other parts of the instrument. The front-panel switch is only a standby switch and is not a LINE switch (disconnecting device).

Rear-Panel Features

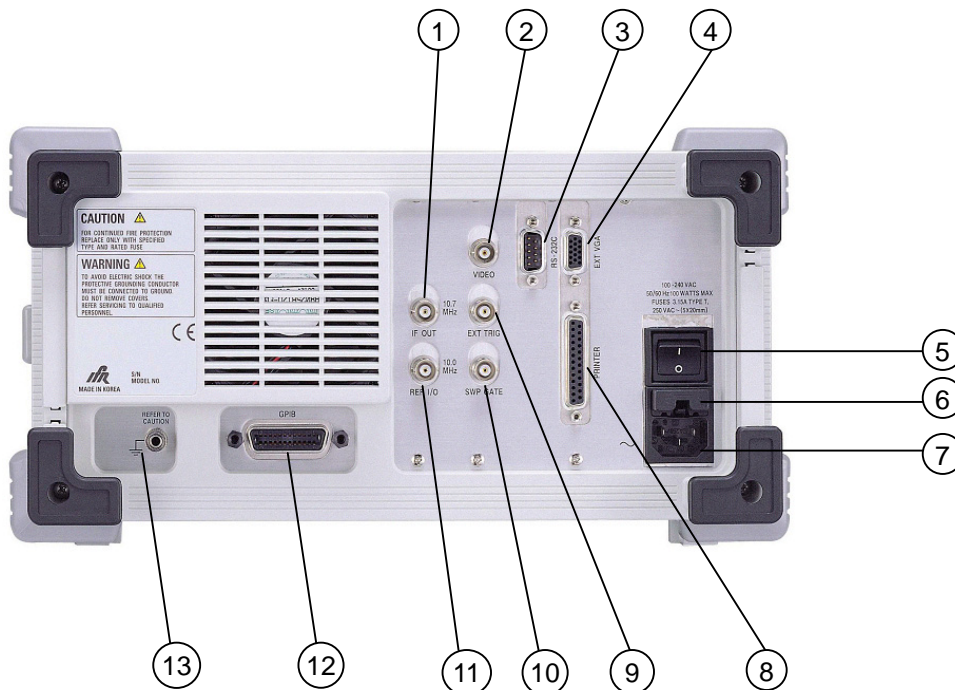

Figure 1-2. Rear-Panel Feature Overview

- ① **IF OUT 10.7 MHz** : IF out Impedance is 50 Ω , 10.7MHz IF output that is the down-converted signal of the RF input of the analyzer. Amplitude-correction factors are not applied to this signal. This output is taken after the resolution bandwidth filters and step gains and before the log amplifier. The output signal will be blanked occasionally during retrace by the automatic alignment routine. When the DRBW option is installed, the 10.7MHz IF signal is not outputted.

- ② **VIDEO** : Video out provides detected video output (before the analog-to-digital conversion) proportional to vertical deflection of the trace. Output is from 0 V to 5V. Amplitude-correction factors are not applied to this signal. The output signal will be blanked occasionally during retrace by the automatic alignment routine.

- ③ **RS-232C** : supports remote instrument operation.

- ④ **EXT VGA** : drives an external VGA compatible monitor.

- ⑤ **(Line Switch)** : This is a main power switch.

- ⑥ **(Line Fuse)** : The fuse is removed by pulling fuse holder. Replace only with a fuse of the same rating. See the label on the rear panel.

- ⑦ **~ (Power input)** : input for the AC line power source. Make sure that the line-power source outlet has a protective ground contact.

- ⑧ **PRINTER** : Parallel port support for printing only.

- ⑨ **EXT TRIG** : accepts the positive edge of an external voltage input(TTL) that triggers the analyzer internal sweep source or the gate function.

- ⑩ **SWEEP GATE** : Output(TTL) signal indicates when the analyzer is sweeping.

- ⑪ **REF I/O 10.0 MHz** : accepts an external frequency source to provide the 10 MHz, -15 to +10 dBm frequency reference used by the analyzer or provides 10MHz, timebase reference signal, with setting *10 MHz Ref.* soft keys to *EXT*. On the contrary REF I/O provides a 10MHz, +5dBm nominal, timebase reference signal, if the *10 MHz Ref.* Soft key is set to *INT*.

- ⑫ **GPIB** : GPIB supports remote instrument operation.(remote control only)

- ⑬  (**Frame Ground Terminal**) : When there is no grounded AC power supply outlet, the protective frame ground terminal must be connected directly to ground potential.



If power is applied without protective grounding, there is a risk of accidental electric shock. The protective frame ground terminal or the ground pin of the supplied power cord must be connected to ground potential before turning the analyzer on.

Display Annotation

Here is an example of the annotation that may appear on an analyzer display. The display annotation is referenced by numbers which are listed in the following table. The Function Key column indicates which key activates the function related to the annotation. Refer to the operation manual for more information on a specific function key.

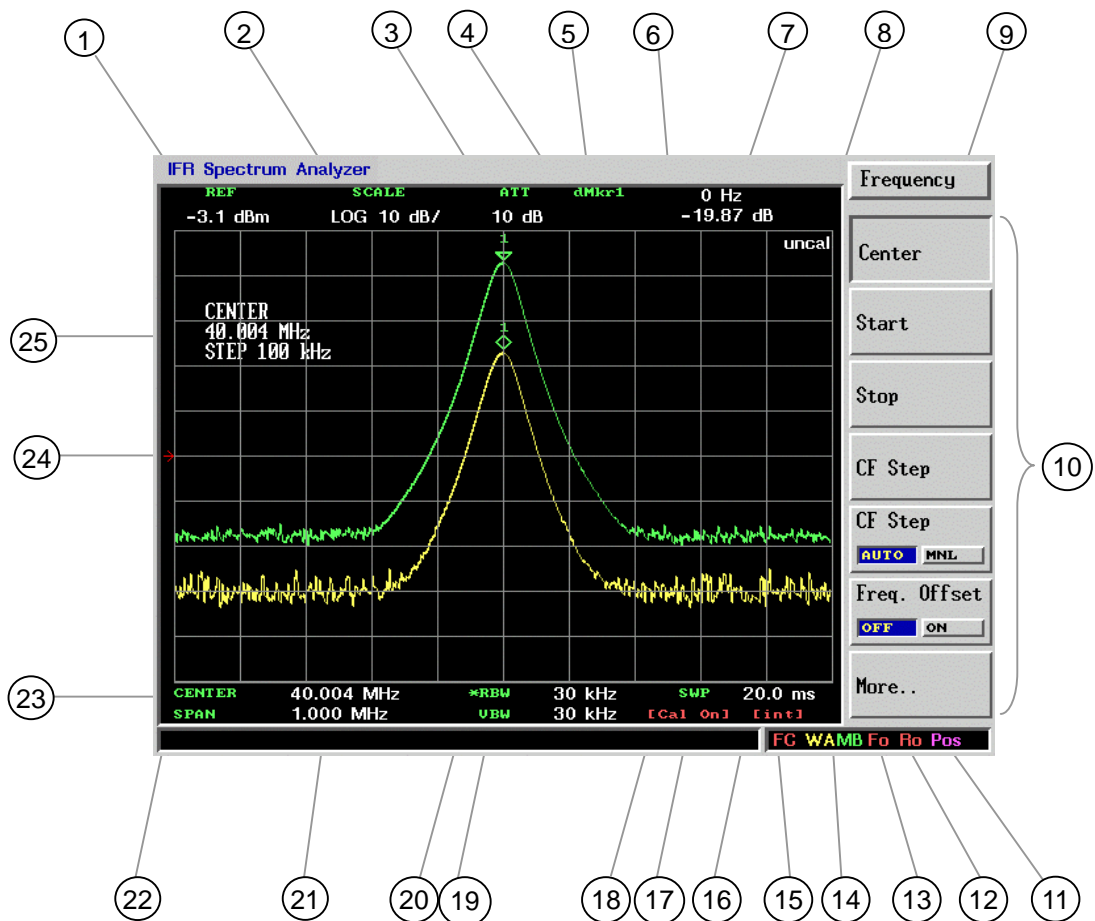
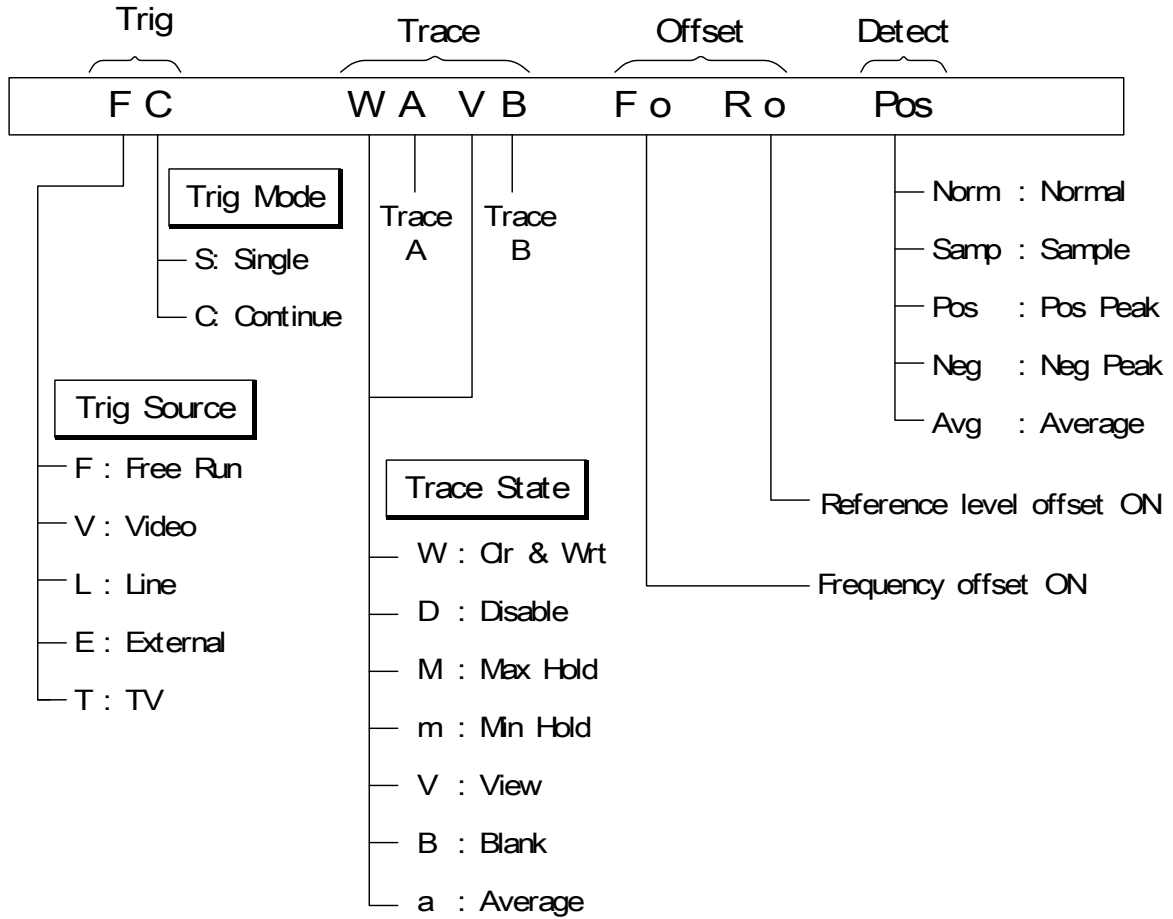

Figure 1-3. Screen Annotation

Table 1-3. Screen annotation

Number	Explanation	Relate key
①	Reference level	AMPL <i>Ref. Level</i>
②	Amplitude scale	AMPL <i>Log, Linear, Scale..</i>
③	Input Attenuation	AMPL <i>Atten. [AUTO/MNL]</i>
④	Marker frequency	MKR
⑤	Date and time display	SYSTEM <i>Clock Set..</i>
⑥	Marker amplitude	MKR
⑦	Screen title	DISP <i>Screen Title..</i>
⑧	Data invalid indicator	CPL
⑨	Key menu title	Dependent on key selection.
⑩	Soft Key menu	See key label descriptions in the previous chapter.
⑪	Detector mode	TRACE <i>Detect.. *ref screen annot. 1-9</i>
⑫	Reference level offset	AMPL <i>Ref. Offset [OFF/ON]</i>
⑬	Frequency offset	FREQ <i>Freq. Offset [OFF/ON]</i>
⑭	Trace mode	TRACE
⑮	Trigger/Sweep	TRIG
⑯	External/Internal frequency reference (10MHz)	FREQ <i>10 MHz Ref. [EXT/INT]</i>
⑰	Internal calibration signal (40MHz, -30dBm) is on	
⑱	Sweep time	CPL <i>Swp Time [AUTO/MNL]</i>
⑲	Video bandwidth	CPL <i>VBW [AUTO/MNL]</i>
⑳	Resolution bandwidth	CPL <i>RBW [AUTO/MNL]</i>
㉑	Display status line	
㉒	Frequency span or stop frequency	SPAN <i>WidthSpan</i> or FREQ <i>Stop</i>
㉓	Center frequency or start frequency	FREQ <i>Center</i> or <i>Start</i>
㉔	Trigger level indicator	TRIG <i>Source..</i>
㉕	Active function block	Refer to the description of the Activated function

11 12 13 14 15 Screen Annotation.



2. MAKING BASIC MEASUREMENTS

What is in This Chapter

This chapter demonstrates basic analyzer measurements with examples of typical measurements; each measurement focuses on different functions. This chapter does not focus on testing equipment performance. This explains spectrum analyzer's simple and basic function and usage example in least extra equipment. For more specific information refer to user's manual chapter 5 or for performance test to chapter 6.

The measurement procedures covered in this chapter are listed below.

- Comparing Signals : 2-2
- Resolving Signals of Equal Amplitude : 2-4
- Resolving Small Signals Hidden by Large Signals : 2-7
- Making Better Frequency Measurements : 2-10
- Decreasing the Frequency Span Around the Signal : 2-12
- Tracking Drifting Signals : 2-14
- Measuring Low Level Signals : 2-19
- Identifying Distortion Products : 2-29
- Making Noise Measurements : 2-33
- Demodulating AM Signals : 2-38
- Demodulating FM Signals : 2-42

Comparing Signals

Using the analyzer, you can easily compare frequency and amplitude differences between signals, such as radio or television signal spectra. The analyzer delta marker function lets you compare two signals when both appear on the screen at one time or when only one appears on the screen.

Example : Delta marker function

Measure the differences between two signals on the same display screen.

1. Connect the 10 MHz REF OUT from the rear panel of Signal Generator to the spectrum analyzer front panel RF INPUT.
2. Set the center frequency to 30 MHz and the span to 50 MHz by pressing **FREQ**, 30 MHz, **SPAN**, 50 MHz.
3. Set the reference level to 10 dBm by pressing **AMPL**, 10dBm.
The 10 MHz reference signal and its harmonics appear on the display.
4. Press **PEAK** to place a marker at the highest peak on the display. (The *NPeakRight* and *NPeakLeft* softkeys are available to move the marker from peak to peak.) The marker should be on the 10 MHz reference signal. See Figure 2-1.

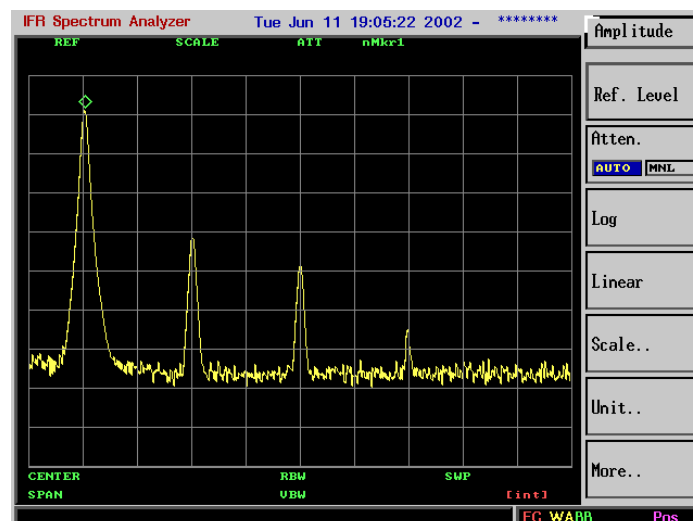

Figure 2-1. Placing a Marker on the 10 MHz Signal

5. Press **MKR**, **Delta**, to activate a second marker at the position of the first marker. Move the second marker to another signal peak using the knob, or by pressing Search and *NPeakRight* or *NPeakLeft*.
6. The amplitude and frequency difference between the markers is displayed in the active function block and in the upper right corner of the screen.
Press **OFF** to turn the markers off.

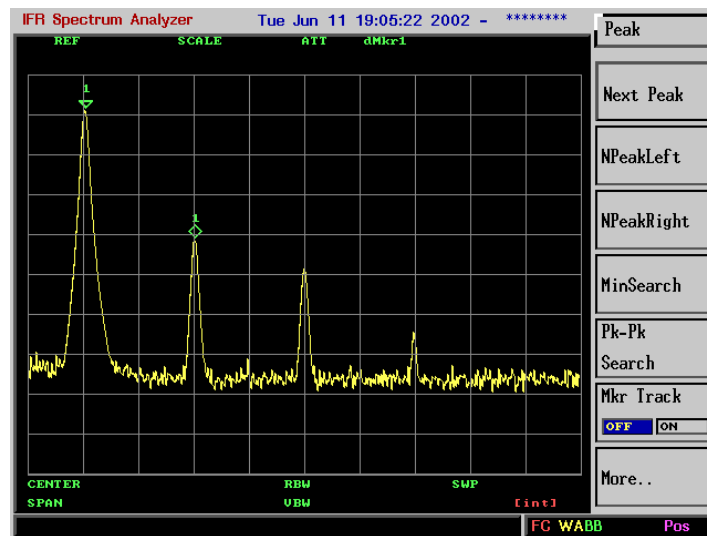

Figure 2-2. Using the Marker Delta Function

Resolving Signals of Equal Amplitude

Two equal-amplitude input signals that are close in frequency can appear as one on the analyzer display. Responding to a single-frequency signal, a swept-tuned analyzer traces out the shape of the selected internal IF (intermediate frequency) filter. As you change the filter bandwidth, you change the width of the displayed response. If a wide filter is used and two equal-amplitude input signals are close enough in frequency, then the two signals appear as one. Thus, signal resolution is determined by the IF filters inside the analyzer.

The bandwidth of the IF filter tells us how close together equal amplitude signals can be and still be distinguished from each other. The resolution bandwidth function selects an IF filter setting for a measurement. Resolution bandwidth is defined as the 3 dB bandwidth of the filter.

Generally, to resolve two signals of equal amplitude, the resolution bandwidth must be less than or equal to the frequency separation of the two signals. If the bandwidth is equal to the separation and the video bandwidth is less than the resolution bandwidth, a dip of approximately 3 dB is seen between the peaks of the two equal signals, and it is clear that more than one signal is present. See Figure 2-4.

In order to keep the analyzer measurement calibrated, sweep time is automatically set to a value that is inversely proportional to the square of the resolution bandwidth (for resolution bandwidths ≥ 1 kHz). So, if the resolution bandwidth is reduced by a factor of 10, the sweep time is increased by a factor of 100 when sweep time and bandwidth settings are coupled. (Sweep time is proportional to $1/BW^2$.) For shortest measurement times, use the widest resolution bandwidth that still permits discrimination of all desired signals. The analyzer allows you to select from 1 kHz to 3 MHz resolution bandwidths in a 1, 3, 10 sequence for maximum measurement flexibility.

Option Digital RBW adds narrower resolution bandwidths, from 10 Hz to 300 Hz, in a 1-3-10 sequence. These bandwidths are digitally implemented and have a much narrower shape factor than the wider, analog resolution bandwidths. Also, the auto coupled sweep times when using the digital resolution bandwidths are much faster than analog bandwidths.

Example : Selection RBW

Resolve two signals of equal amplitude with a frequency separation of 100 kHz.

1. Connect two sources to the analyzer **RF INPUT** as shown in Figure 2-3.

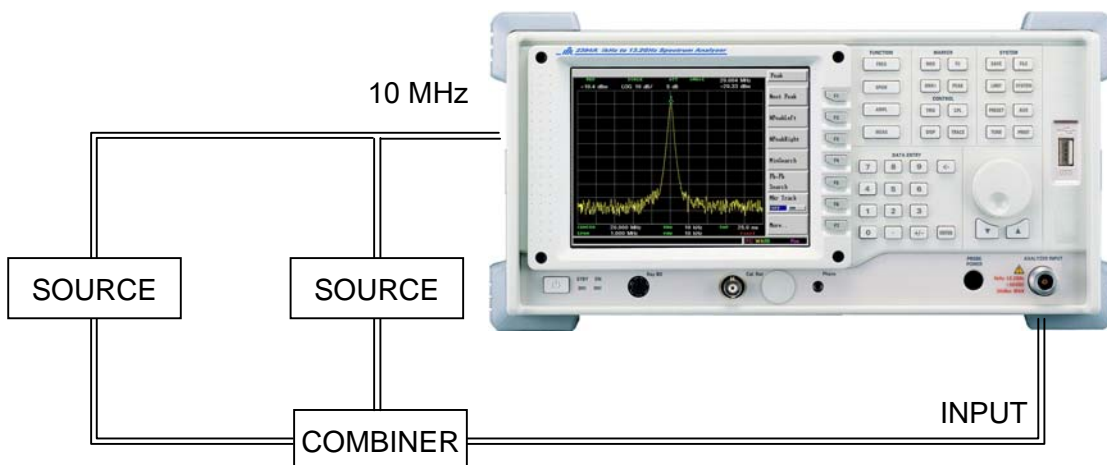

Figure 2-3. Setup for Obtaining Two Signals

2. Set one source to 300 MHz. Set the frequency of the other source to 300.1 MHz. The amplitude of both signals should be approximately -10 dBm.
3. On the analyzer, Press **PRESET**, *Preset*. Set the center frequency to 300 MHz, the span to 2 MHz, and the resolution bandwidth to 300 kHz by setting **FREQ**, 300 MHz, **SPAN**, 2 MHz, then **CPL**, *RBW AUTO MNL[MNL]*, *RBW*, 300 kHz. A single signal peak is visible.

NOTE :

If the signal peak cannot be found, increase the span to 20 MHz by pressing **SPAN**, 20 MHz. The signal should be visible. Press **PEAK**, **MKR>**, *Mkr>CF*, then **SPAN**, 2 MHz to bring the signal to center screen.

- Since the resolution bandwidth must be less than or equal to the frequency separation of the two signals, a resolution bandwidth of 100 kHz must be used. Change the resolution bandwidth to 100 kHz by setting **RBW, 100 kHz**. Two signals are now visible as shown in Figure 2-4. Use the knob or step keys to further reduce the resolution bandwidth and better resolve the signals.

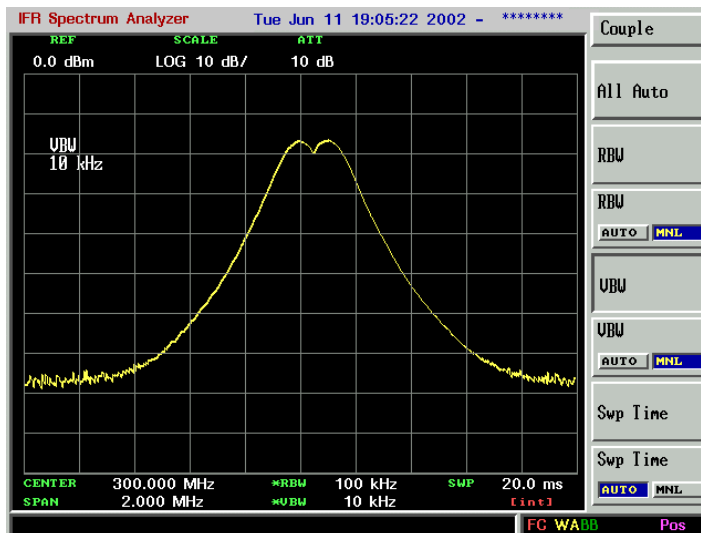

Figure 2-4. Resolving Signals of Equal Amplitude

- Decrease the video bandwidth to 10 kHz, by pressing **CPL**, **VBW AUTO MNL(MNL)**, **VBW 10 kHz**. As the resolution bandwidth is decreased, resolution of the individual signals is improved and the sweep time is increased. For fastest measurement times, use the widest possible resolution bandwidth. Under couple conditions, the resolution bandwidth is “coupled” (or linked) to the span.

Since the resolution bandwidth has been changed from the coupled value, a * mark appears next to **RBW** in the lower-left corner of the screen, indication that the resolution bandwidth is uncoupled. (Ref. All Auto Function 5-37)

NOTE :

To resolve two signals of equal amplitude with a frequency separation of 200 kHz, the resolution bandwidth must be less than the signal separation, and resolution of 100 kHz must be used. The next larger filter, 300 kHz, would exceed the 200 kHz separation and would not resolve the signals.

Resolving Small Signals Hidden by Large Signals

When dealing with the resolution of signals that are close together and not equal in amplitude, you must consider the shape of the IF filter of the analyzer, as well as its 3dB bandwidth. (See “Resolving Signals of Equal Amplitude” on page 2-5 example for more information.) The shape of a filter is defined by the selectivity, which is the ratio of the 60 dB bandwidth to the 3 dB bandwidth. If a small signal is too close to a larger signal, the smaller signal can be hidden by the skirt of the larger signal. To view the smaller signal, you must select a resolution bandwidth such that k is less than a . See Figure 2-5.

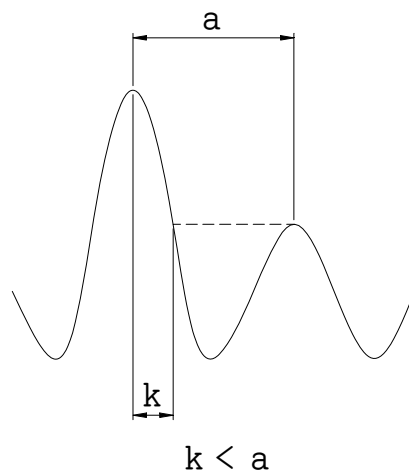

Figure 2-5. Resolution Bandwidth Requirements for Resolving Small Signals

The separation between the two signals (a) must be greater than half the filter width of the larger signal (k) measured at the amplitude level of the smaller signal.

Example : Selection RBW

Resolve two input signals with a frequency separation of 200 kHz and different amplitude.

1. To obtain two signals with a 200 kHz separation, connect the equipment as shown in the previous section, “Resolving Signals of Equal Amplitude” on page 2-5. Set one source to 300 MHz at -10 dBm.
2. Set the analyzer center frequency to 300 MHz and the span to 1 MHz : press **FREQ**, 300 MHz, then **SPAN**, 1 MHz.

NOTE : If the signal peak cannot be found, increase the span to 10 MHz by pressing **SPAN**, 10 MHz. The signal should be visible. Press **PEAK**, **MKR>**, **Mkr>CF** to bring the signal to center screen, then **SPAN**, 1 MHz.

3. Set the second source to 300.200 MHz, so that the signal is 200 kHz higher than the first signal. Set the amplitude of the signal to -70 dBm (60 dB below the first signal).

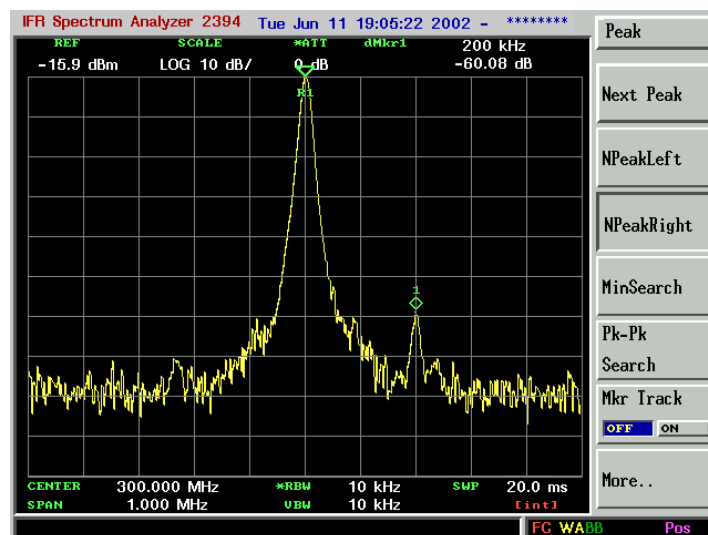

Figure 2-6. Signal Resolution with a 10 kHz Resolution Bandwidth

4. Set the 300 MHz signal to the reference level by pressing **PEAK**, then **MKR>**,

MKR>Ref.

If a 10 kHz filter with a typical shape factor 15:1 is used, the filter will have a bandwidth of 150 kHz at the 60dB point, the half-bandwidth (75 kHz) is narrower than the frequency separation, so the input signals will be resolved. See Figure 2-6.

5. Place a marker on the smaller signal by pressing **MKR**, *Delta*, **PEAK**, *NPeakRight*. If a 30 kHz filter is used, the 60 dB bandwidth could be as wide as 450 kHz. Since then half-bandwidth (225 kHz) is wider than the frequency separation(200 kHz), the signals most likely will not be resolved. See Figure 2-7. (In this example, we used the 60 dB bandwidth value. To determine resolution capability for intermediate values of amplitude level differences, assume the filter skirts between the 3 dB and 60 dB points are approximately straight.)

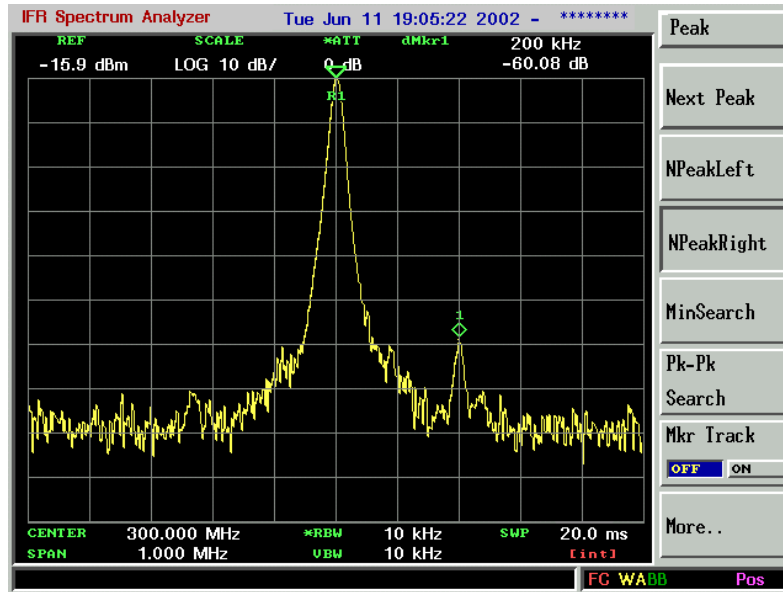

Figure 2-7. Signal Resolution with a 30 kHz Resolution Bandwidth

Making Better Frequency Measurements

A built-in frequency counter increases the resolution and accuracy of the frequency readout.

Example : Marker counter function

Increase the resolution and accuracy of the frequency readout on the signal of interest.

1. Connect CAL. OUT to RF INPUT with BNC-BNC cable and N-BNC adapter in front panel.

2. Turn on the internal 20 MHz calibration signal of the analyzer (if you have not already done so). Press **AMPL**, More..., *Cal. Out [20M] [ON]*.
3. Set the center frequency to 20 MHz by pressing **FREQ**, 20 MHz.
4. Set the span to 10 MHz by pressing **SPAN**, 10 MHz.
5. Press **FC**, *Counter* The counted result appears in the upper-right corner of the screen and also displays on marker table in the bottom screen. Marker table can be off by pressing **MKR**, *More...*, *MKR Table [ON]* so that ON is highlighted.
6. Move the marker on the peak of the signal, with pressing **PEAK**.

NOTE :

Marker count properly functions only on CW signals of discrete spectral components and its level is more than -70 dBm.

7. Increase the counter resolution by pressing **FC**, *Counter* and then setting the desired resolution using the step keys or the knob. The marker counter readout is in the upper-right corner of the screen. The resolution can be set from 1 Hz to 1 kHz in decade step.
8. The marker counter remains on until turned off. Turn off the marker counter by pressing **FC**, *Off* or **MKR**, *OFF*.

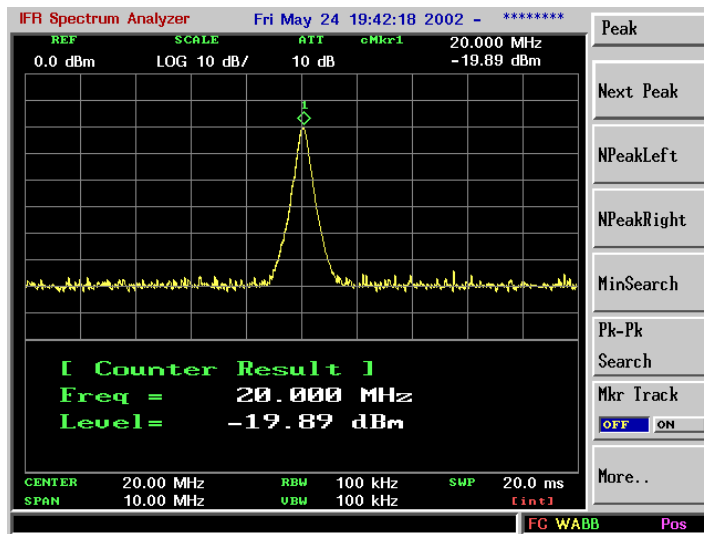

Figure 2-8. Using Marker Counter

Decreasing the Frequency Span Around the Signal

Using the analyzer signal tracking function, you can quickly decrease the span while keeping the signal at center frequency. This is a fast way to take a closer look at the area around the signal to identify signals that would otherwise not be resolved.

Example : Mkr Track function

Examine a signal in a 200 kHz span.

1. Connect CAL. OUT to RF INPUT with BNC-BNC cable and N-BNC adapter in front panel.
2. Turn on the internal Cal Signal 20 MHz calibration signal of the analyzer (if you have not already done so). Press **AMPL**, More..., *Cal. Out [20M] [ON]*.
3. Set the center frequency to 20 MHz by pressing **FREQ**, *Center, 20 Mhz*.
4. Press **PEAK** to place a marker at the peak.
5. Press **PEAK**, *Mkr Track [On]* and the signal will move to the center of the screen, if it is not already positioned there. (Note that the marker must be on the signal before turning signal tracking on.) Because the signal tracking function automatically maintains the signal at the center of the screen, you can reduce the span quickly for a closer look. If the signal drifts off of the screen as you decrease the span, use a wider frequency span.
6. Press **SPAN**, 200 kHz. The span decreases in steps as automatic zoom is completed. See Figure 2-9. You can also use the scroll knob or step keys to decrease the span or use the *Zoom* function under **SPAN**.

Press **PEAK**, *Mkr Track [OFF]* again (so that Off is highlighted) to turn off the signal tracking function.

NOTE :

When you are finished with the example, turn off the signal tracking function.

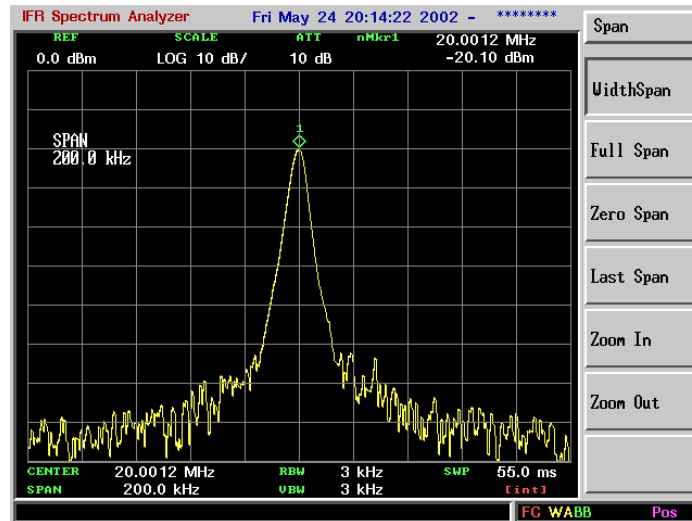

Figure 2-9. After Zoom-In on the Signal

Tracking Drifting Signals

The signal tracking function is useful for tracking drifting signals that drift relatively slowly.

PEAK, *Mkr Track* may be used to track these drifting signals. Use **PEAK** to place a marker on the signal you wish to track. Pressing **PEAK**, *Mkr Track [ON]* will bring that signal to the center frequency of the graticule and adjust the center frequency every sweep to bring the selected signal back to the center.

Note that the primary function of the signal tracking function is to track unstable signals, not to track a signal as the center frequency of the analyzer is changed. If you choose to use the signal tracking function when changing center frequency, check to ensure that the signal found by the tracking function is the correct signal.

Example 1 : Mkr Track function

Use the signal tracking function to keep a drifting signal at the center of the display and monitor its change.

This example requires signal generator. The frequency of the signal generator will be changed while you view the signal on the display of the analyzer.

1. Connect a signal generator to the analyzer **RF INPUT**. Press **PRESET**, **Preset**.
2. Set the signal generator frequency to 300 MHz with an amplitude of -20 dBm.
3. Set the center frequency of the analyzer to 300 MHz by pressing **FREQ**, **300 MHz**.
4. Press **PEAK** to move the marker to the peak of your signal.

5. Set the span to 10 MHz by pressing **SPAN**, 10 MHz.
6. Press **SPAN**, 500 kHz.

Notice that the signal has been held in the center of the display.

7. The signal frequency drift can be read from the screen if both the signal tracking and marker delta functions are active. Press **PEAK**, *Mkr Track [ON]*. The marker readout indicates the change in frequency and amplitude as the signal drifts.
8. Tune the frequency of the signal generator. Notice that the center frequency of the analyzer changes in < 10 kHz increments, centering the signal with each increment.

See Figure 2-10.

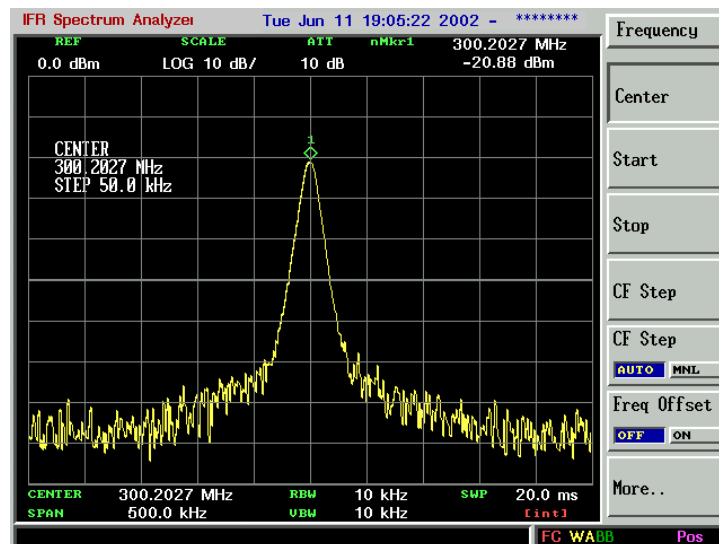

Figure 2-10. Using Signal Tracking to Track a Drifting Signal

Example 2 : Max Hold function

The analyzer can measure the short-and long-term stability of a source. The maximum amplitude level and the frequency drift of an input signal trace and be displayed and held by using the maximum-hold function. You can also use the maximum hold function if you want to determine how much of the frequency spectrum a signal occupies.

1. Connect a signal generator to the analyzer **RF INPUT**. Press **PRESET**, *Preset*.
2. Set the signal generator frequency to 300 MHz with an amplitude of -20 dBm.
3. Set the center frequency of the analyzer to 300 MHz by pressing **FREQ**, **300 MHz**.
4. Press **PEAK** to move the marker to the peak of your signal.
5. Set the span to 10 MHz by pressing **SPAN**, **10 MHz**.
6. Press **SPAN**, **500 kHz**.
7. To measure the excursion of the signal, press **TRACE** then **Max Hold**. As the signal varies, maximum hold maintains the maximum responses of the input signal.

Annotation on the left side of the screen indicates the trace mode(MAX HOLD) as MA
WB. (ref. Annotation 1-10)

- Press **Select [B]** to select trace B. (Trace B is selected when All A change to B in menu.) Press **Clr & Wrt** to place trace B in clear-write mode, which displays the current measurement results as it sweeps. Trace A remains in maximum hold mode, showing the frequency shift of the signal.

Slowly change the frequency of the signal generator ± 50 kHz. Your analyzer display should look similar to Figure 2-11.

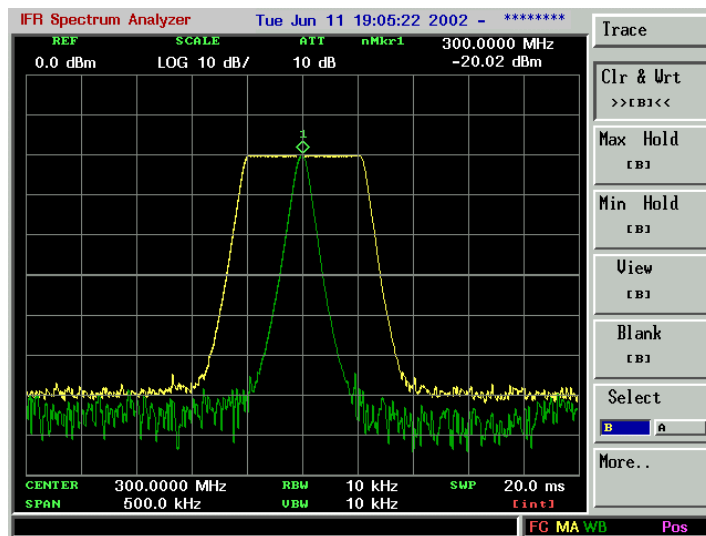

Figure 2-11. Viewing a Drifting Signal with Max Hold and Clear Write

Measuring Low Level Signals

The ability of the analyzer to measure low level signals is limited by the noise generated inside the analyzer. A signal may be masked by the noise floor so that it is not visible. This sensitivity to low level signals is affected by the measurement setup.

The analyzer input attenuator and bandwidth setting affect the sensitivity by changing the signal-to-noise ratio. The attenuator affects the level of a signal passing through the instrument, whereas the bandwidth affects the level of internal noise without affecting the signal. In the first two examples in this section, the attenuator and bandwidth settings are adjusted to view low level signals.

If, after adjusting the attenuation and resolution bandwidth, a signal is still near the noise, visibility can be improved by using the video bandwidth and video averaging functions, as demonstrated in the third and fourth examples.

Example 1 : Set input attenuation

If a signal is very close to the noise floor, reducing input attenuation brings the signal out of the noise. Reducing the attenuation to 0 dB maximizes signal power in the analyzer.

CAUTION

The total power of all input signals at the analyzer input must not exceed the maximum power level for the analyzer.

1. Connect a signal generator to the analyzer **RF INPUT**. Press **PRESET**, *Preset* on the analyzer.
2. Set the signal generator frequency to 300 MHz with an amplitude of -80 dBm.
3. Set the center frequency of the analyzer to 300 MHz by pressing **FREQ**, 300 MHz.
4. Set the span to 5 MHz by pressing **SPAN**, 5 MHz.
5. Set the reference level to -40dBm by pressing **AMPL**, *Ref Level*, -40 dBm.
6. Place the signal at center frequency by pressing **PEAK**, **MKR>**, *Mkr>CF*.
7. Reduce the span to 1 MHz. Press **SPAN**, and then use the step-down key (▼). See

Figure 2-12.

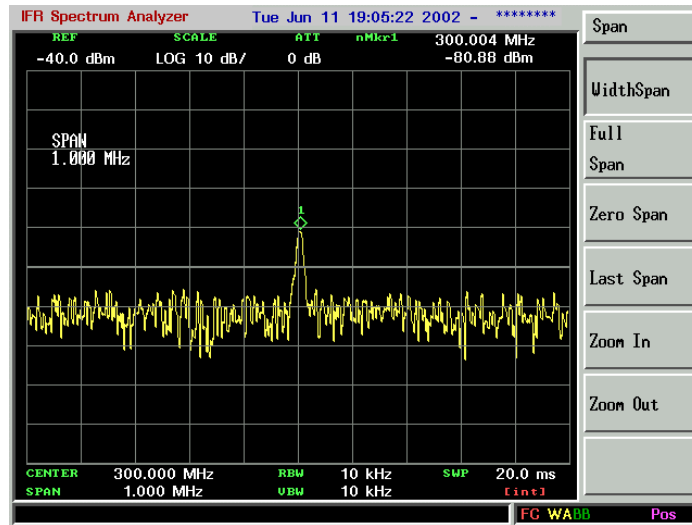

Figure 2-12. Using 0 dB Attenuation

8. Press **AMPL**, *Atten [MNL]*. Press the step-up key (\blacktriangle) to select 10 dB attenuation.

Increasing the attenuation moves the noise floor closer to the signal. See Fig 2-13. A * mark appears next to the ATT annotation at the top of the display, indicating the attenuation is no longer coupled to other analyzer setting.

9. To see the signal more clearly, enter 0 dB or *Atten [AUTO]*. Zero attenuation makes the signal more visible.



Before connecting other signals to the analyzer input, increase the RF attenuation to protect the analyzer input.

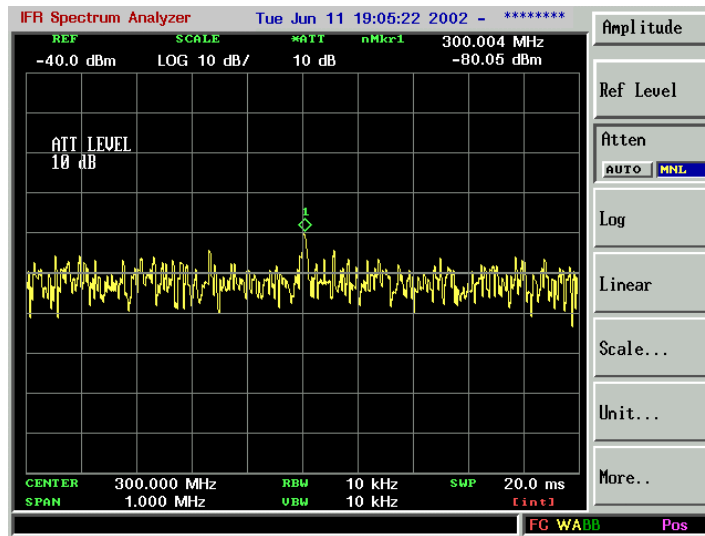

Figure 2-13. Low-Level Signal with 10dB Attenuation

Example 2 : Selection RBW

The resolution bandwidth can be decreased to view low level signals.

1. As in the previous example, set the analyzer to view a low level signal. Connect a signal generator to the analyzer **RF INPUT**. Press **PRESET**, *Preset* on the analyzer.
2. Set the signal generator frequency to 300 MHz with an amplitude of -80 dBm.
3. Set the center frequency of the analyzer to 300 MHz by pressing **FREQ**, **300 MHz**.
4. Set the span to 1 MHz by pressing **SPAN**, **1 MHz**.
5. Set the reference level to -40 dBm by pressing **AMPL**, *Ref Level*, **-40 dBm**.

6. Press **CPL**, **RBW [MNL]**, **RBW**, and the step-down key (**▼**) to decrease RBW. The low level signal appears more clearly because the noise level is reduced. See Figure 2-14.

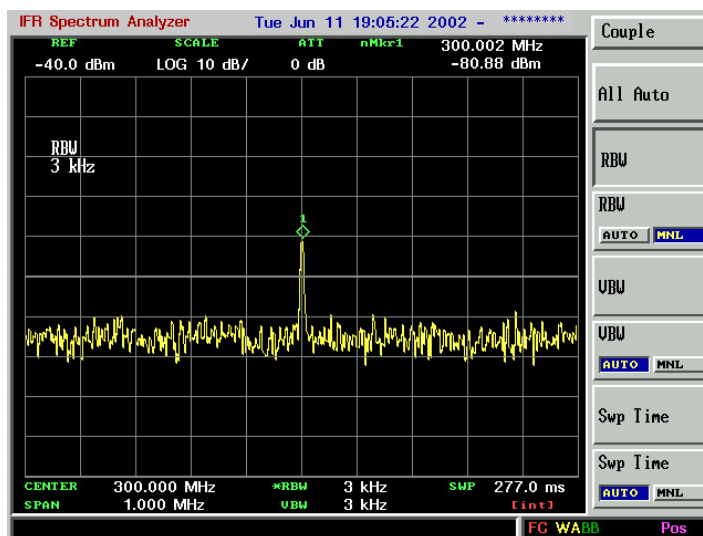

Figure 2-14. Decreasing Resolution Bandwidth

A * mark appears next to the RBW annotation at the lower center of the screen, indicating that the resolution bandwidth is uncoupled.

As the resolution bandwidth is reduced, the sweep time is increased to maintain calibrated data.

Example 3 : Selection VBW

Narrowing the video filter can be useful for noise measurements and observation of low level signals close to the noise floor. The video filter is a post-detection low-pass filter that smoothes the displayed trace. When signal responses near the noise level of the analyzer are visually masked by the noise, the video filter can be narrowed to smooth this noise and improve the visibility of the signal. (Reducing video bandwidths requires slower sweep times to keep the analyzer calibrated.)

Using the video bandwidth function, measure the amplitude of a low level signal.

1. As in the previous example, set the analyzer to view a low level signal. Connect a signal generator to the analyzer **RF INPUT**. Press PRESET, *Preset* on the analyzer.
2. Set the signal generator frequency to 300 MHz with an amplitude of -80 dBm.
3. Set the center frequency of the analyzer to 300 MHz by pressing FREQ, **300 MHz**.
4. Set the span to 1 MHz by pressing SPAN, **1 MHz**.
5. Set the reference level to -40dBm by pressing AMPL, *Ref Level*, **-40dBm**.

- Set the video bandwidth to 100Hz by pressing **CPL**, **VBW [MNL]**, **VBW**, and the step-down key (∇). This clarifies the signal by smoothing the noise, which allows better measurement of the signal amplitude.

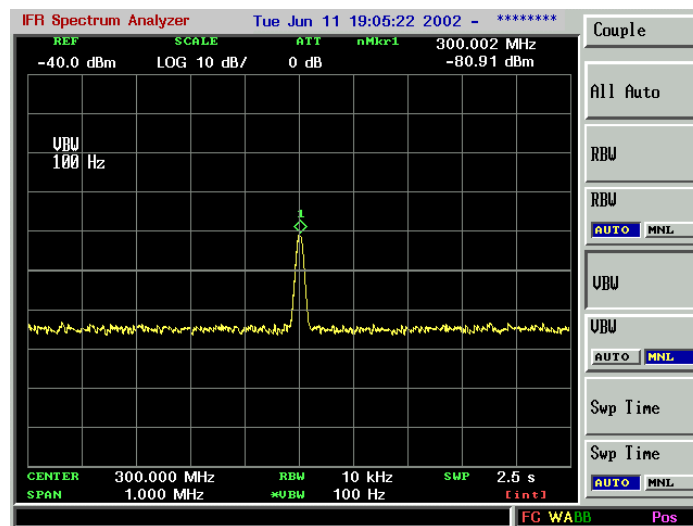

Figure 2-15. Decreasing Video Bandwidth

A * mark appears next to the VBW annotation at the bottom of the screen, indicating that the video bandwidth is not coupled to the resolution bandwidth. See Figure 2-15.

Instrument preset conditions couple the video bandwidth to the resolution bandwidth so that the video bandwidth is equal to the resolution bandwidth. If the bandwidths are uncoupled when video bandwidth is the active function, pressing *VBW [AUTO]* (so that Auto is highlighted) recouples the bandwidths.

NOTE :

The video bandwidth must be set wider than the resolution bandwidth when measuring impulse noise levels.

Example 4 : Video average function

If a signal level is very close to the noise floor, video averaging is another way to make the signal more visible.

NOTE :

The time required to construct a full trace that is averaged to the desired degree is approximately the same when using either the video bandwidth or the video averaging technique. The video bandwidth technique completes the averaging as a slow sweep is taken, whereas the video averaging technique takes many sweeps to complete the average. Characteristics of the signal being measured, such as drift and duty cycle, determine which technique is appropriate.

Video averaging is a digital process in which each trace point is averaged with the previous trace-point average. Video averaging clarifies low-level signals in wide bandwidths by averaging the signal and the noise.

1. As in the previous example, set the analyzer to view a low level signal. Connect a signal generator to the analyzer **RF INPUT**. Press **PRESET**, *Preset* on the analyzer.
2. Set the signal generator frequency to 300 MHz with an amplitude of –80 dBm.
3. Set the center frequency of the analyzer to 300 MHz by pressing **FREQ**, **300 MHz**.
4. Set the span to 1 MHz by pressing **SPAN**, **1 MHz**.
5. Set the reference level to –40 dBm by pressing **AMPL**, *Ref Level*, **-40 dBm**.
6. Press **TRACE**, *More...*, *Average..* then *Average [ON]*. When ON is highlighted, the video averaging routine is initiated. As the averaging routine smoothes the trace, low level signals become more visible. *Average Count [8]* appears on the right-upper screen.

The number represents the number of samples (or sweeps) taken to complete the averaging routine.

- To set the number of samples, press *Count* and use the numbers keypad. For example, press *Average [ON]* (so that ON is highlighted), **2, 5, ENTER**. Reset will initialize current average and start averaging.

During averaging, the current sample number appears in the right-upper screen. The sampling will also restart if video averaging is turned off and then on again.

Once the set number of sweeps has been completed, the analyzer continues to provide a running average based on this set number.

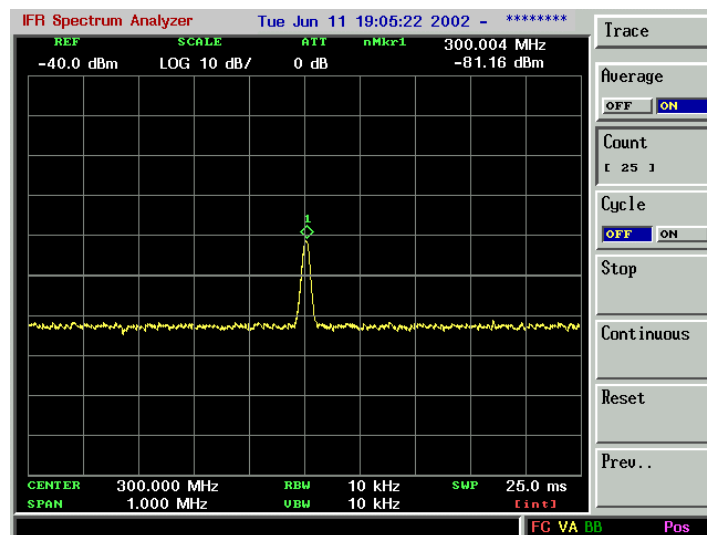

Figure 2-16. Using the Video Averaging Function

Identifying Distortion Products

Distortion from the Analyzer

High level input signals may cause analyzer distortion products that could mask the real distortion measured on the input signal.

Example : Delta marker function

Using a signal from a signal generator, determine how many the harmonic distortion products are generated by the analyzer. Fine distortion measurement is possible when suppress the input signal's distortion.

1. Connect a signal generator to the analyzer **RF INPUT**. Set the signal generator frequency to 200 MHz and the amplitude to 0 dBm.
2. Set the center frequency of the analyzer to 400 MHz and the span to 500 MHz by pressing **FREQ**, 400 MHz, **SPAN**, 500 MHz.

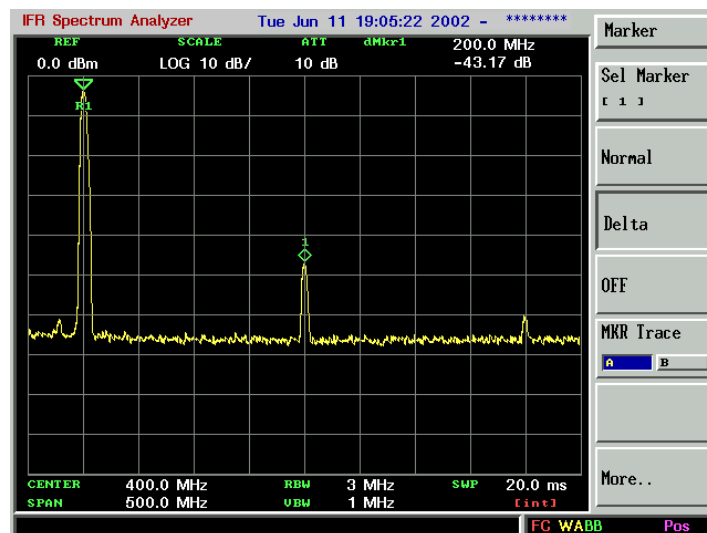

Figure 2-17. Harmonic Distortion

To measure the second harmonic distortion, press **PEAK** then the marker is located in the highest signal, fundamental signal(200MHz). Press **MKR**, *Delta*, and *200MHz*, then the marker is located in the second harmonic signal. The signal shown in Figure 2-17 produces harmonic distortion products in the analyzer input mixer.

Notice that you must consider the harmonic distortion product, when measuring the high level signal.

Third-Order Intermodulation Distortion

Two-tone, third-order intermodulation distortion is a common test in communication systems. When two signals are present in a non-linear system, they can interact and create third-order intermodulation distortion products that are located close to the original signals. These distortion products are generated by system components such as amplifiers and mixers.

Example : Delta marker function

Test a device for third-order intermodulation. This example uses two sources, one set to 300 MHz and the other to approximately 301 MHz. (Other source frequencies may be substituted, but try to maintain a frequency separation of approximately 1 MHz.)

1. Connect the equipment as shown in Figure 2-18. Press **PRESET**, *Preset*.

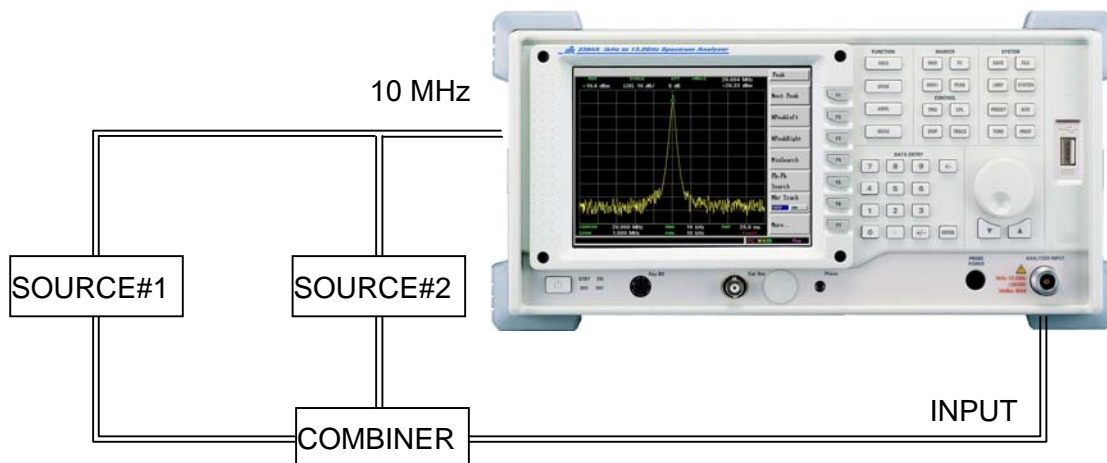

Figure 2-18. Third-Order Intermodulation Equipment Setup

NOTE :

The combiner should have a high degree of isolation between the two input ports so the sources do not intermodulate.

2. Set one source to 300 MHz and the other source to 301 MHz, for a frequency separation of 1 MHz. Set the sources equal in amplitude (in this example, they are set to -5 dBm).
3. Tune both signals onto the screen by setting the center frequency 300.5 MHz. Then, using the knob, center the two signals on the display. Reduce the frequency span to 5 MHz. This is wide enough to include the distortion products on the screen. To be sure the distortion products are resolved, reduce the resolution bandwidth until the distortion products are visible.
4. Press **CPL**, **RBW [MNL]**, **RBW**, and then use the step-down key (∇) to reduce the resolution bandwidth until the distortion products are visible.
5. To measure a distortion product, press **Marker** to place a marker on a source signal. To activate the second marker, press **MKR**, **Delta**. Using the knob, adjust the second marker to the peak of the distortion product that is beside the test signal. The difference between the markers is displayed in the upper-right screen.

To measure the other distortion product, press **PEAK**, **NpeakLeft** or **NPeakRight**. This places a marker on the next highest peak, which, in this case, is the other source signal. To measure the difference between this test signal and the second distortion product, press **MKR** **Delta** and use the knob to adjust the second marker to the peak of the second distortion product. See Figure 2-19.

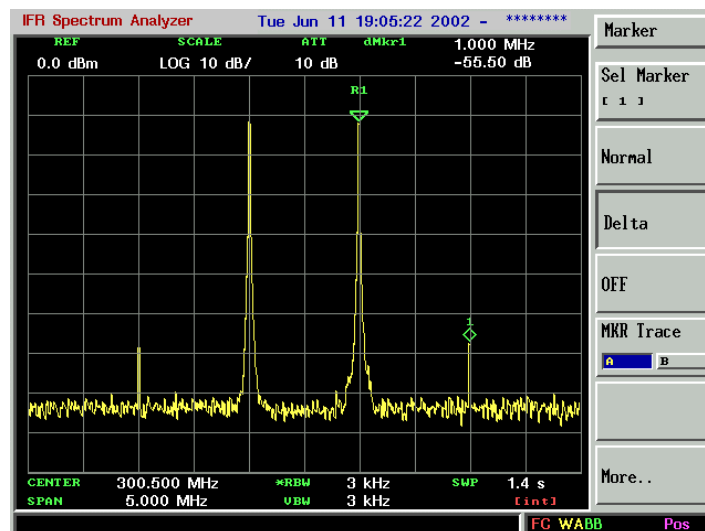

Figure 2-19. Measuring the Distortion Product

Making Noise Measurements

There are a variety of ways to measurement noise power. The first decision you must make is whether you want to measure noise power at a specific frequency or the total power over a specified frequency range, for example over a channel bandwidth.

Example 1 : MKR Noise function

Using the marker function, **MKR Noise**, is a simple method to make a measurement at a single frequency. In this example, attention must be made to the potential errors due to discrete signal (spectral components). This measurement will be made near the 20 MHz amplitude reference signal to illustrate the use of **MKR Noise**.

1. Connect CAL. OUT to RF INPUT with BNC-BNC cable and N-BNC adapter in front panel.
2. Turn on the internal 20 MHz calibration signal of the analyzer (if you have not already done so). Press **AMPL**, *More...*, *Cal. Out [20M] [ON]*.
3. Tune the analyzer to the frequency of interest. In this example we are using the reference signal. Press **FREQ**, **19.98 MHz**.
4. Set the span the 50 kHz by pressing **SPAN**, **50 kHz**.

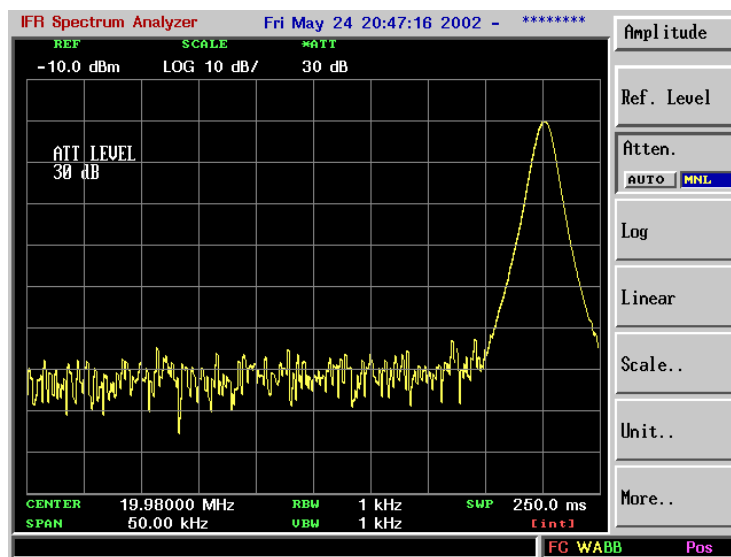

Figure 2-20. Setting the input attenuator

5. Set the reference level to -10 dBm by pressing **AMPL**, *Ref Level, -10 dBm*. See Figure 2-20. Note that if the signal is much higher than shown, adjust the input attenuator. In this example the input attenuation was set to 30dB by pressing *Atten. [MNL], 30dB*.
6. Activate the noise marker by pressing **MKR**, *More., Function., MKR Noise*. Note that the display detection has changed to sample, the marker floats between the maximum and the minimum of the noise. The marker readout is in dBm or dBm per bandwidth. See Figure 2-21. For noise power in a different bandwidth, add $10 \times \log(BW)$. For example, for noise power in a 1 kHz bandwidth, add $10 \times \log(1000)$ or 30dB to the noise marker value.

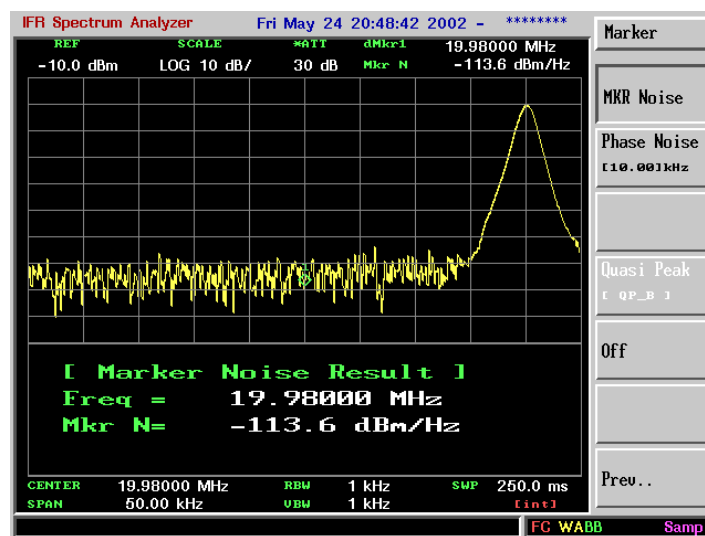

Figure 2-21. Activating the Noise Marker function

7. Video filtering can be introduced to reduce the variations of the sweep-to-sweep marker value. Set the video filter by pressing **CPL**, *VBW [MNL], VBW, 100 Hz*.

Notice that these variations are to be expected due to the nature of the signal. We can reduce the variations by introducing video filtering. Since reducing the video bandwidth filter impacts sweep time, it is recommended to limit the degree of filtering.

Example 2 : Video filtering/Average

The Normal marker can also be used to make a signal frequency measurement as described in the previous example, again using video filtering or averaging to obtain a reasonably stable measurement.

While video averaging automatically selects the sample display detection mode, video filtering does not. With sufficient filtering that results in a smooth trace there is no difference between the sample and peak modes because the filtering takes place before the signal is digitized.

Be sure to account for the fact that the averaged noise is displayed approximately 2 dB too low for a noise bandwidth equal to the resolution bandwidth. Therefore, you must add 2 dB to the marker reading. For example, if the marker indicates -100 dBm, the actual noise level is -98 dBm.

Example 3 : Channel power measurement

You may want to measure the total power of a noise-like signal that occupies some bandwidth. For example, you may want to determine the power in a communications channel. If the signal is noise and is flat across the band of interest, you can use the noise marker as described in example 1 and add $10 \times \log(\text{channel BW})$. However, if you are not certain of the characteristics of the signal, or if there are discrete spectral components in the band of interest, we can use the Channel Power routine. In this example, you will use the noise of the analyzer then add a discrete tone to see what happens and assume a channel bandwidth of 50 kHz. If desired, a specific signal may be substituted.

1. Reset the analyzer by pressing **PRESET**, *Preset*.
2. Connect CAL. OUT to RF INPUT with BNC-BNC cable and N-BNC adapter in front panel.
3. Tune the analyzer to the frequency of 20 MHz. In this example we are using the amplitude reference signal. Press **FREQ**, 20 MHz.
4. Set the span to 100 kHz by pressing **SPAN**, 1 MHz.
5. Set the reference level to -20dBm by pressing **AMPL**, *Ref Level*, -20 dBm.
6. Set the input attenuation to 50dB by pressing **AMPL**, *Atten [MNL]*, 50dB.
7. Set the analyzer to setup the channel-power measurement by pressing **MEAS**, *Channel Power...*
8. Set the integration bandwidth to 500 kHz by pressing *Integ BW*, 500 kHz.
9. Set the channel-power span to 1 MHz by pressing *Ch PWR Span*, 1 MHz.

NOTE :

The display detection mode has been set to sample and the video bandwidth has been set to be ten times wider than the resolution bandwidth. This setting is important to prevent any averaging. You can reduce the sweep-to-sweep variation in the power reading by averaging over a number of sweeps.

10. Turn average number on by pressing *Meas. Avg. [ON]*. Add a discrete tone to see the affects of the reading. Turn on the internal 20 MHz calibration signal of the analyzer (if you have not already done so). Press **AMPL**, *More.., Cal. Out [20M] [ON]*.

The channel power reading is essentially equal to 20 MHz calibration signal. The total noise power is far enough below that of the tone that the noise power contributes very little to the total.

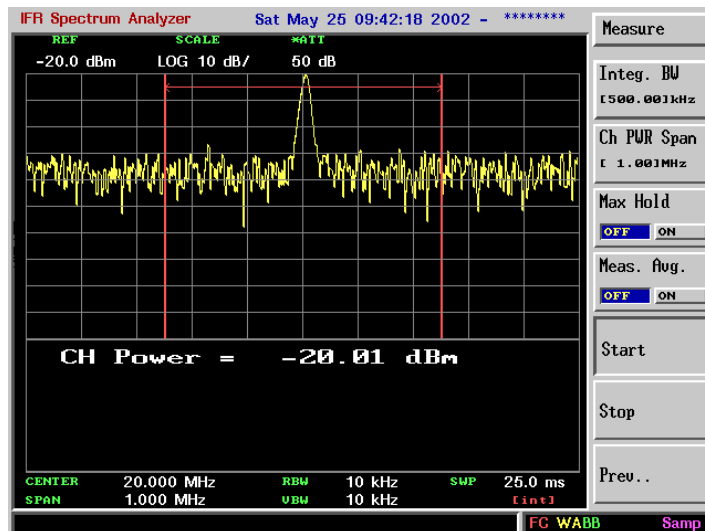

Figure 2-22. Measuring Channel Power

The algorithm that computes the total power compensates for the fact that some of the trace points on the response to the continuous wave tone may be at or very close to the peak value of the tone and so yields the correct value whether the signal comprises just noise, a tone, or both.

Demodulating AM Signals

The zero span mode can be used to recover amplitude modulation on a carrier signal. The analyzer operates as fixed-tuned receiver in zero span to provide time domain measurements.

Center frequency in the swept-tuned mode becomes the tuned frequency in zero span. The horizontal axis of the screen becomes calibrated in time only, rather than both frequency and time. Markers display amplitude and time values.

The following functions establish a clear display of the waveform:

- Trigger stabilizes the waveform trace on the display by triggering on the modulation envelope. If the modulation of the signal is stable, video trigger synchronizes the sweep with the demodulated waveform.
- Linear mode should be used in amplitude modulation (AM) measurements to avoid distortion caused by the logarithmic amplifier when demodulation signals.
- Sweep time adjusts the full sweep time from 20 ms to 1000 s (from 25 μ s to 15 s in zero span). The sweep time readout refers to the full 10-division graticule. Divide this value by 10 to determine sweep time per division.
- Resolution and video bandwidth are selected according to the signal bandwidth.

Each of the coupled function values remains at its current value when zero span is activated. Video bandwidth is coupled to resolution bandwidth. Sweep time is not coupled to any other function.

Example : AM Demod. Function

View the modulation waveform of an AM signal in the time domain.

1. To obtain an AM signal, you can either connect a source to the analyzer input and set the source for amplitude modulation, or connect an antenna to the analyzer input and tune to a commercial AM broadcast station. This example uses a source. (If you are using a commercial broadcast station as your signal, press **AUX**, **AM Demod. [ON]** to turn on AM demodulation. Then press **Audio Sound [ON]**, and the analyzer will operate as a radio.)
2. Connect a signal generator output to the analyzer RF INPUT.
3. Set a source output frequency to 300 MHz, AM rate to 400Hz, and AM depth to 50%.
4. Set the center frequency of the analyzer to 300 MHz by pressing **FREQ**, **300 MHz**.
5. To demodulate the AM, press **AUX**, **AM Demod. [ON]**. See Figure 2-23.

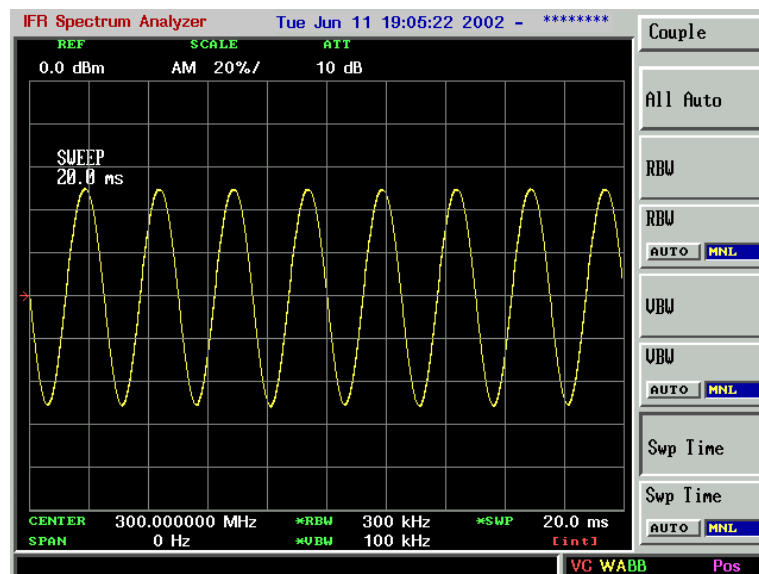

Figure 2-23. Measuring Modulation Using AM Demodulation Function.

Another method to demodulate AM signal is using zero span by repeating the step 1 to 4 and performing the following steps.

6. Set the span to 20 MHz by pressing **SPAN**, 20 MHz.
7. Set the resolution bandwidth to 1 MHz by pressing **CPL**, *RBW [MNL]*, *RBW, 1 MHz*. See Figure 2-24.



Figure 2-24. Viewing an AM Signal

8. Increase the resolution bandwidth to include both sidebands of the signal within the 1 dB passband of the analyzer (about 2/3 of the 3 dB BW).
9. To select zero span, either press **SPAN**, 0 Hz, or press **SPAN**, *Zero Span*.
10. Next, position the signal peak near the reference level and select a linear voltage display. Press **AMPL**, *Linear, Ref Level*, then adjust the reference level.
11. Adjust the sweep time to change the horizontal scale by pressing **CPL**, *Swp Time [MNL]*, *Swp Time, 10 ms*. See Figure 2-25.

If the modulation is a steady tone, for example from a signal generator, use video trigger to trigger on the waveform and stabilize the display. (If you are viewing an off-the-air signal you will not be able to stabilize the waveform.)

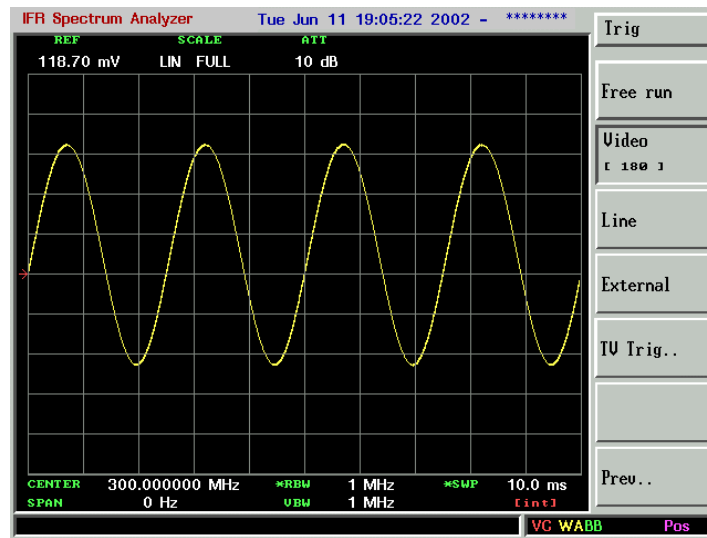

Figure 2-25. Measuring Modulation in Zero Span.

Use markers and delta markers to measure the time parameters of the waveform.

Demodulating FM Signals

As with amplitude modulation you can utilize zero span to demodulate a FM signal. However, unlike the AM case, you cannot simply tune to the carrier frequency and widen the resolution bandwidth. The reason is that the envelope detector in the analyzer responds only to amplitude variations, and there is no change in amplitude if the frequency changes of the FM signal are limited to the flat part of the resolution bandwidth.

You can demodulate FM signals by using the FM demodulation function.

On the other hand, if you tune the analyzer slightly away from the carrier, you can utilize slope detection to demodulate the signal by performing the following steps.

1. Determine the correct resolution bandwidth.
2. Fine the center of the linear portion of the filter skirt (either side).
3. Tune the analyzer to put the center point at mid screen of the display.
4. Select zero span.

The demodulated signal is now displayed; the frequency changes have been translated into amplitude changes. See the following figure. To listen to the signal, turn on AM demodulation and the speaker.

In this example you will demodulate a broadcast FM signal that has a specified 75 kHz peak deviation.

Example 1 : Delta marker function

Determine the correct resolution bandwidth. With a peak deviation of 75 kHz, your signal has a peak-to-peak excursion of 150 kHz. So we must find a resolution bandwidth filter with a skirt that is reasonably linear over that frequency range.

1. Connect CAL. OUT to RF INPUT with BNC-BNC cable and N-BNC adapter in front panel.

2. Turn on the internal 20 MHz calibration signal of the analyzer (if you have not already done so). Press **AMPL**, *More...*, **Cal. Out [20M] [ON]**.
3. Tune the analyzer to the frequency 20 MHz. In this example we are using the amplitude reference signal. Press **FREQ**, **20 MHz**.
4. Set the span to 1 MHz by pressing **SPAN**, **1 MHz**.
5. Set the reference level to -20dBm by pressing **AMPL**, **Ref Level, -20 dBm**.
6. Set the resolution bandwidth to 100 kHz by pressing **CPL**, **RBW [MNL], RBW, 100 kHz**.
The skirt is reasonably linear starting about half a division down from the peak.
7. Select a marker by pressing **MKR**, then move the marker approximately half a division down the right of the peak (high frequency) using the front-panel knob.
8. Place a delta marker 150 kHz from the first marker by pressing **Delta**, **150 kHz**. The skirt looks reasonably linear between markers.
9. Determine the offset from the signal peak to the desired point on the filter skirt by moving the delta marker to the midpoint. Press **75 kHz** to move the delta marker to the midpoint. See Figure 2-26.

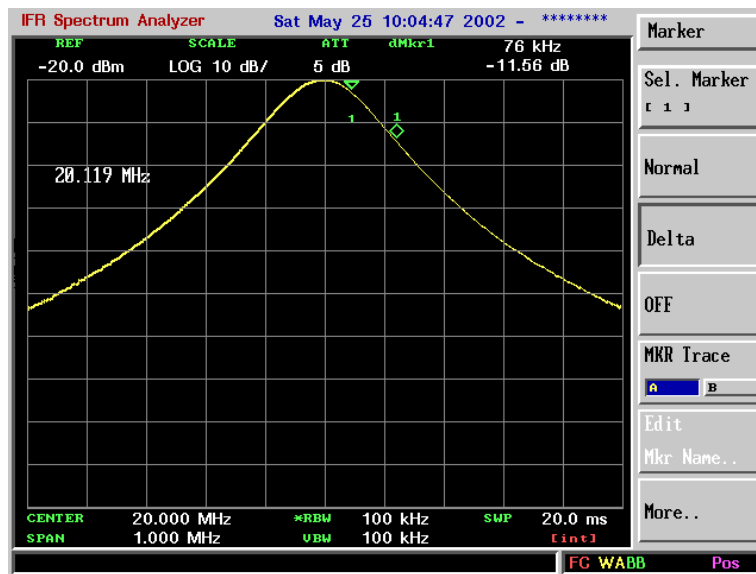

Figure 2-26. Determining the Offset

10. Press **Delta** to make the active marker the reference marker.
11. Press **PEAK** to move the delta marker to the peak. The delta value is the desired offset, for example 130 kHz.

Example 2 : FM Demod. Function

1. Connect a signal generator output to the analyzer RF INPUT.
2. Set a source frequency to 300 MHz, amplitude to 0 dBm, FM deviation to 75 kHz, and FM rate to 1 kHz.
3. Reset the analyzer by pressing **PRESET**, *Preset*.
4. Tune the analyzer to 300 MHz by pressing **FREQ**, 300 MHz.

First, Demodulate the FM signal by using the FM demodulation function.

5. Demodulate the FM signal by pressing **AUX**, *FM Demod. [ON]*.
6. To Listen the signal(1 kHz), press *Audio Sound [ON]*.
7. Adjust the sweep time by pressing **CPL**, *Swp Time [MNL]*, *Swp Time 10 ms*.

See Figure 2-27.

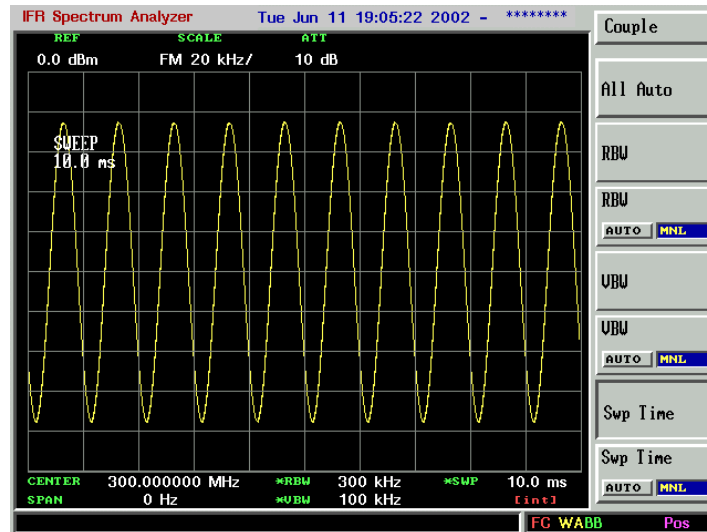

Figure 2-27. Measuring Modulation Using FM Demodulation Function

Another method is using zero span by repeating the step 1 to 4 and performing the following steps.

8. Tune above or below the FM signal by the offset noted above in step 10, in this example 130 kHz. press **FREQ**, *CF Step [MNL], CF Step, 130 kHz, Center* then use the step-up key (**▲**) or step-down key (**▼**).
9. Set the resolution bandwidth to 100 kHz, then go to zero span by pressing **CPL**, *RBW [MNL], RBW, 100 kHz, SPAN*, and *Zero Span*.
10. Activate signal sweep by pressing **TRIG**, *Single*.
11. Listen to the demodulated signal through the speaker by pressing **AUX**, *Audio Sound [ON], FM Demod. [ON], Audio Level* then adjust the volume using the front-panel knob or the step-key.

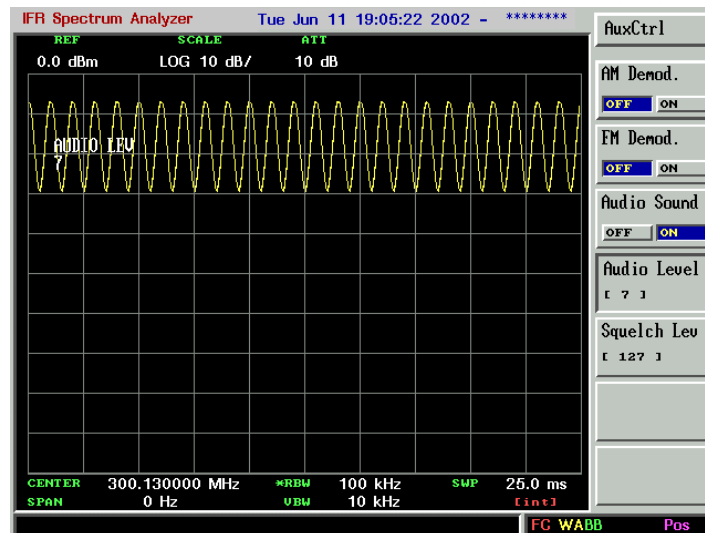

Figure 2-28. Measure the demodulation in Zero Span

Rev01, 02/2007

AEROFLEX INTERNATIONAL LTD. SOFTWARE LICENCE AND WARRANTY

This document is an Agreement between the user of this Licensed Software, the Licensee, and Aeroflex International Limited, the Licensor. By opening this Software package or commencing to use the software you accept the terms of this Agreement. If you do not agree to the terms of this Agreement please return the Software package unopened to Aeroflex International Limited or do not use the software.

1. DEFINITIONS

The following expressions will have the meanings set out below for the purposes of this Agreement:

Add-In Application Software	Licensed Software that may be loaded separately from time to time into the Equipment to improve or modify its functionality
Computer Application Software	Licensed Software supplied to run on a standard PC or workstation
Designated Equipment	the single piece of Equipment upon which the licensed software is installed
Downloaded Software	any software downloaded from an Aeroflex web site
Embedded Software	Licensed Software that forms part of the Equipment supplied by Aeroflex and without which the Equipment cannot function
Licence Fee	the consideration ruling at the date of this Agreement for the use of one copy of the Licensed Software on the Designated Equipment
Licensed Software	All and any programs, listings, flow charts and instructions in whole or in part including Add-in, Computer Application, Downloaded and Embedded Software supplied to work with Designated Equipment

2. LICENCE FEE

The Licensee shall pay the Licence Fee to Aeroflex in accordance with the terms of the contract between the Licensee and Aeroflex.

3. TERM

This Agreement shall be effective from the date hereof and shall continue in force until terminated under the provisions of Clause 9.

4. LICENCE

- 4.1 Unless and until terminated, this Licence confers upon the Licensee the non-transferable and non-exclusive right to use the Licensed Software on the Designated Equipment.
- 4.2 The Licensee may not use the Licensed Software on other than the Designated Equipment, unless written permission is first obtained from Aeroflex and until the appropriate additional Licence Fee has been paid to Aeroflex.
- 4.3 The Licensee may not amend or alter the Licensed Software and shall have no right or licence other than that stipulated herein.
- 4.4 The Licensee may make not more than two copies of the Licensed Software (but not the Authoring and Language Manuals) in machine-readable form for operational security and shall ensure that all such copies include Aeroflex's copyright notice, together with any features which disclose the name of the Licensed Software and the Licensee. Furthermore, the Licensee shall not permit the Licensed Software or any part to be disclosed in any form to any third party and shall maintain the Licensed Software in secure premises to prevent any unauthorised disclosure. The Licensee shall notify Aeroflex immediately if the Licensee has knowledge that any unlicensed party possesses the Licensed Software. The Licensee's obligation to maintain confidentiality shall cease when the Licensed Software and all copies have been destroyed or returned. The copyright in the Licensed Software shall remain with Aeroflex. The Licensee will permit Aeroflex at all reasonable times to audit the use of the Licensed Software.
- 4.5 The Licensee will not disassemble or reverse engineer the Licensed Software, nor sub-licence, lease, rent or part with possession or otherwise transfer the whole or any part of the Licensed Software.

5. WARRANTY

- 5.1 Aeroflex certifies that the Licensed Software supplied by Aeroflex will at the time of delivery function substantially in accordance with the applicable Software Product Descriptions, Data Sheets or Product Specifications published by Aeroflex.
 - 5.2 The warranty period (unless an extended warranty for Embedded Software has been purchased) from date of delivery in respect of each type of Licensed Software is:

Embedded Software	12 months
Add-In Application Software	90 days
Computer Application Software	90 days
Downloaded Software	No warranty
 - 5.3 If during the appropriate Warranty Period the Licensed Software does not conform substantially to the Software Product Descriptions, Data Sheets or Product Specifications Aeroflex will provide:
 - 5.3.1 In the case of Embedded Software and at Aeroflex's discretion either a fix for the problem or an effective and efficient work-around.
 - 5.3.2 In the case of Add-In Application Software and Computer Application Software and at Aeroflex's discretion replacement of the software or a fix for the problem or an effective and efficient work-around.
 - 5.4 Aeroflex does not warrant that the operation of any software will be uninterrupted or error free.
-

6 The above Warranty does not apply to:

- 6.1 Defects resulting from software not supplied by Aeroflex, from unauthorised modification or misuse or from operation outside of the specification.
- 6.2 Third party produced Proprietary Software which Aeroflex may deliver with its products, in such case the third party Software Licence Agreement including its warranty terms shall apply.
- 7 The remedies offered above are sole and exclusive remedies and to the extent permitted by applicable law are in lieu of any implied conditions, guarantees or warranties whatsoever and whether statutory or otherwise as to the software all of which are hereby expressly excluded.

8. INDEMNITY

- 8.1 Aeroflex shall defend, at its expense, any action brought against the Licensee alleging that the Licensed Software infringes any patent, registered design, trademark or copyright, and shall pay all Licensor's costs and damages finally awarded up to an aggregate equivalent to the Licence fee provided the Licensee shall not have done or permitted to be done anything which may have been or become any such infringement and shall have exercised reasonable care in protecting the same failing which the Licensee shall indemnify Aeroflex against all claims costs and damages incurred and that Aeroflex is given prompt written notice of such claim and given information, reasonable assistance and sole authority to defend or settle such claim on behalf of the Licensee. In the defence or settlement of any such claim, Aeroflex may obtain for the Licensee the right to continue using the Licensed Software or replace it or modify it so that it becomes non-infringing.
- 8.2 Aeroflex shall not be liable if the alleged infringement:
 - 8.2.1 is based upon the use of the Licensed Software in combination with other software not furnished by Aeroflex, or
 - 8.2.2 is based upon the use of the Licensed Software alone or in combination with other software in equipment not functionally identical to the Designated Equipment, or
 - 8.2.3 arises as a result of Aeroflex having followed a properly authorised design or instruction of the Licensee, or
 - 8.2.4 arises out of the use of the Licensed Software in a country other than the one disclosed to Aeroflex as the intended country of use of the Licensed Software at the commencement of this Agreement.
- 8.3 Aeroflex shall not be liable to the Licensee for any loss of use or for loss of profits or of contracts arising directly or indirectly out of any such infringement of patent, registered design, trademark or copyright.

9. TERMINATION

- 9.1 Notwithstanding anything herein to the contrary, this Licence shall forthwith determine if the Licensee:
 - 9.1.1 As an individual has a Receiving Order made against him or is adjudicated bankrupt or compounds with creditors or as a corporate body, compounds with creditors or has a winding-up order made against it or
 - 9.1.2 Parts with possession of the Designated Equipment.
- 9.2 This Licence may be terminated by notice in writing to the Licensee if the Licensee shall be in breach of any of its obligations hereunder and continue in such breach for a period of 21 days after notice thereof has been served on the Licensee.
- 9.3 On termination of this Agreement for any reason, Aeroflex may require the Licensee to return to Aeroflex all copies of the Licensed Software in the custody of the Licensee and the Licensee shall, at its own cost and expense, comply with such requirement within 14 days and shall, at the same time, certify to Aeroflex in writing that all copies of the Licensed Software in whatever form have been obliterated from the Designated Equipment.

10. THIRD PARTY LICENCES

The software or part thereof may be the proprietary property of third party licensors. In such an event such third party licensors (as referenced on the package or the Order Acknowledgement) and/or Aeroflex may directly enforce the terms of this Agreement and may terminate the Agreement if the Licensee is in breach of the conditions contained herein.

11. EXPORT REGULATIONS

The Licensee undertakes that where necessary the Licensee will conform with all relevant export regulations imposed by the Governments of the United Kingdom and/or the United State of America.

12. NOTICES

Any notice to be given by the Licensee to Aeroflex shall be addressed to:

Aeroflex International Limited, Longacres House, Six Hills Way, Stevenage, SG1 2AN, UK.

13. LAW AND JURISDICTION

This Agreement shall be governed by the laws of England and shall be subject to the exclusive jurisdiction of the English courts. This agreement constitutes the whole Contract between the parties and may be changed only by memorandum signed by both parties.

© AEROFLEX INTERNATIONAL LTD 2004

**CHINA Beijing**

Tel: [+86] (10) 6539 1166
Fax: [+86] (10) 6539 1778

CHINA Shanghai

Tel: [+86] (21) 5109 5128
Fax: [+86] (21) 5150 6112

FINLAND

Tel: [+358] (9) 2709 5541
Fax: [+358] (9) 804 2441

FRANCE

Tel: [+33] 1 60 79 96 00
Fax: [+33] 1 60 77 69 22

GERMANY

Tel: [+49] 8131 2926-0
Fax: [+49] 8131 2926-130

HONG KONG

Tel: [+852] 2832 7988
Fax: [+852] 2834 5364

INDIA

Tel: [+91] 80 5115 4501
Fax: [+91] 80 5115 4502

KOREA

Tel: [+82] (2) 3424 2719
Fax: [+82] (2) 3424 8620

SCANDINAVIA

Tel: [+45] 9614 0045
Fax: [+45] 9614 0047

SPAIN

Tel: [+34] (91) 640 11 34
Fax: [+34] (91) 640 06 40

UK Burnham

Tel: [+44] (0) 1628 604455
Fax: [+44] (0) 1628 662017

UK Stevenage

Tel: [+44] (0) 1438 742200
Fax: [+44] (0) 1438 727601
Freephone: 0800 282388

USA

Tel: [+1] (316) 522 4981
Fax: [+1] (316) 522 1360
Toll Free: (800) 835 2352

As we are always seeking to improve our products, the information in this document gives only a general indication of the product capacity, performance and suitability, none of which shall form part of any contract. We reserve the right to make design changes without notice.

web www.aeroflex.com

Email info-test@aeroflex.com

November 2005